

MAPro10

Numerical 3phase over current + earth fault relay



S: STANDARD SAFETY STATEMENTS

S – 1: Attention:

The information in the Safety Section of the equipment documentation is intended to ensure that equipment is properly installed and handled in order to maintain it in a safe condition.

It is assumed that everyone who will be associated with the equipment will be familiar with safety instructions.

When electrical equipment is in operation, dangerous voltages will be present in certain parts of the equipment. Failure to care, incorrect use, or improper use may endanger personnel and equipment and also cause personal injury or physical damage.

Before working in the terminal strip area, the equipment must be isolated.

Proper and safe operation of the equipment depends on appropriate shipping and handling, proper storage, installation and commissioning, and on careful operation, maintenance and servicing. For this reason only qualified personnel may work on or operate the equipment.

S – 1.1: Qualified personnel are individuals who:

- Are familiar with the installation, commissioning, and operation of the equipment and of the system to which it is being connected;
- Are able to safely perform switching operations in accordance with accepted safety engineering practices and are authorized to energize and de-energize equipment and to isolate, ground, and label it.
- Are familiar in the care and use of safety apparatus in accordance with safety engineering practices;
- Are familiar in emergency procedures (first aid).

The equipment documentation gives instructions for its installation, commissioning, and operation. However, the manual cannot cover all conceivable circumstances or include detailed information on all topics. In the event of questions or specific problems, do not take any action without proper authorization. Contact the appropriate FMA technical sales office and request the necessary information.

S – 2: Technical specifications for safety

Unless otherwise stated in the equipment technical manual, the following data is applicable:

S – 2.1: Protective fuse rating

The recommended maximum rating of the external protective fuse for equipment is 16A, high rupture capacity (HRC) Red Spot type NIT, or TIA, or equivalent. Unless otherwise stated in equipment technical manual, the following data is applicable. The protective fuse should be located as close to the unit as possible.

CAUTION - CTs must NOT be fused since open circuiting them may produce lethal hazardous voltages.

S – 2.2: Protective class

IEC 60255-27: 2005, EN 60255-27: 2006

Class I (unless otherwise specified in the equipment documentation). This equipment requires a protective conductor (earth) connection to ensure user safety.

S – 2.3: Installation category

IEC 60255-27: 2005, EN 60255-27: 2006

Installation Category III

Distribution level, fixed installation.

Equipment in this category is qualification tested at 5 kV peak, 1.2/50 μ s, 500 Ω , 0.5 J, between all supply circuits and earth and also between independent circuits.

S – 2.4: Environment

The equipment is intended for indoor installation and use only. If it is required for use in an outdoor environment then it must be mounted in a specific cabinet or housing or front covered with special FMA cover which will enable it to meet the requirements of IEC 60529 with the classification of degree of protection IP54 (dust and splashing water protected).

Pollution Degree - Pollution Degree 2 Compliance is demonstrated by reference

Altitude - Operation up to 2000m to safety standards.

IEC 60255-27:2005

EN 60255-27: 2006

I: INTRODUCTION

I – 1: Introducing MAPro10

The **MAPro10** range of FMA relays are universal over current and earth fault relays.

This type of relays have been designed to control, protect and monitor industrial installations, public distribution networks and substations and for EHV and HV transmission networks.

MAPro10 relays provide comprehensive over current protection. In addition to its protective functions, each relay offers control and recording features, such as trip circuit supervision, circuit breaker control, inrush restrain, thermal overload, multi shot auto reclosing, broken conductor, cold load pick up, negative sequence over current, and under current with blocking facility.

They can be fully integrated to a control system so protection, control, data acquisition and recording of faults, events and disturbances can be made available.

Table1 shows the functions which are available in several types of MAPro10x relays.

The relays are equipped on the front panel with a liquid crystal display (LCD) including 2 x 16 back-light alphanumeric characters, a tactile 7 button numerical keypad (to access all settings, clear alarms and read measurements) and 7 fully configurable LEDs that indicate the status of **MAPro10** relays plus one green healthy LED which blinks every second when relay is OK.

In **MAPro10/T2** type, the configurable LEDs are increased to 10, and also the front keypad contains numerical keys to make the settings easier.

In addition, the use of the front USB communication port makes it possible to read, reinitialize and change the settings of the relays, if required, from a local computer loaded with related PC software. Also by the rear RS485 communication port it possible to read, reinitialize and change the settings of the relays, read fault, and events with time tag, from a remote terminal software.

Also it is easily possible to access to events, faults, and disturbances via the USB front connector. If you have the system password, you will be able to change the settings via this connector. All of the a.m. facilities are possible by the special **FMA MAPro setting PC software** installed on a PC or laptop.

Its flexibility of use, reduced maintenance requirements and ease of integration allow the MAPro relays, to provide an adaptable solution for the problems of the protection of electric networks.

I – 2: General considerations

I – 2.1: Receipt of relays

MAPro protective relays, although generally of robust construction, require careful treatment prior to installation on site. Upon receipt, relays should be examined immediately to ensure no damage has been sustained in transit. If damage has been sustained during transit a claim should be made to the transport contractor and also FMA should be promptly notified.

Relays that are supplied not mounted and not intended for immediate installation should be returned to their protective Styrofoam case.

I – 2.2: Electrostatic discharge (ESD)

The relays use components that are sensitive to electrostatic discharges.

The electronic circuits are well protected by the metal case and the internal module should not be withdrawn unnecessarily. When handling the module outside its case, care should be taken to avoid contact with components and electrical connections. If removed from the case for storage, the module should be placed in an electrically conducting antistatic bag.

There are no setting adjustments within the module and it is advised to avoid unnecessary disassembling. Although the printed circuit boards are plugged together, the connectors are a manufacturing aid and not intended for frequent dismantling; in fact considerable effort may be required to separate them. Touching the printed circuit board should be avoided, since complementary metal oxide semiconductors (CMOS) are used, which can be damaged by static electricity discharged from the body.

I – 2.3: Handling of electronic equipment

A person's normal movements can easily generate electrostatic potentials of several thousand volts. Discharge of these voltages into semiconductor devices when handling electronic circuits can cause serious damage, which often may not be immediately apparent *but the reliability of the circuit will have been reduced*.

The electronic circuits are completely safe from electrostatic discharge when housed in the case. Do not expose them to risk of damage by withdrawing modules unnecessarily.

Each module incorporates the highest practicable protection for its semiconductor devices. However, if it becomes necessary to withdraw a module, the following precautions should be taken to preserve the high reliability and long life for which the equipment has been designed and manufactured.

1. Before removing a module, ensure that you are at the same electrostatic potential as the equipment by touching the case which is connected to the protective conductor terminal.
2. Handle the module by its *front plate special handle*, frame or edges of the printed circuit board. Avoid touching the electronic components, printed circuit track or connectors.
3. Do not pass the module to another person without first ensuring you are both at the same electrostatic potential. Shaking hands achieves equal potential.
4. Place the module on an antistatic surface, or on a conducting surface which is at the same potential as yourself.
5. Store or transport the module in its protective Styrofoam case.

If you are making measurements on the internal electronic circuitry of an equipment in service, it is preferable that you are earthed to the case with a conductive wrist strap.

Wrist straps should have a resistance to ground between 500k Ω – 10M Ω .

If a wrist strap is not available you should maintain regular contact with the case to prevent a build-up of static. Instrumentation which may be used for making measurements should be earthed

to the case whenever possible. More information on safe working procedures for all electronic equipment can be found in BS5783 and IEC 147-OF. It is strongly recommended that detailed investigations on electronic circuitry or modification work should be carried out in a special handling area such as described in the above-mentioned BS and IEC documents.

I – 2.4: Relay mounting

Relays are dispatched either individually or as part of a panel/rack assembly.

If an **MAL-TB01** test block is to be included it should be positioned at the right-hand side of the assembly (viewed from the front). Modules should remain protected by their metal case during assembly into a panel or rack.

For individually mounted relays an outline diagram is supplied with relay packing and also in this technical guide showing the panel cut-outs and drilling centers.

I – 2.5: Unpacking

Care must be taken when unpacking and installing the relays so that none of the parts is damaged or the settings altered. Relays must only be handled by skilled persons. The installation should be clean, dry and reasonably free from dust and excessive vibration.

The site should be well lit to facilitate inspection. Relays that have been removed from their cases should not be left in situations where they are exposed to dust or damp. This particularly applies to installations which are being carried out at the same time as construction work.

I – 2.6: Storage

If relays are not to be installed immediately upon receipt they should be stored in a place free from dust and moisture in their original cartons.

It is better to care about dust which collects on a carton may, on subsequent unpacking, find its way into the relay, or in damp conditions the carton and packing may become impregnated with moisture.

Storage temperature: -25°C to $+70^{\circ}\text{C}$.

I - 3: Main functions

The table in the next page shows the functions available for the different models of the **MAPro10** range of relays.

ctions	Ansi code	MAPro 105 3phase overcurrent plus earth fault	MAPro 105/T2 3phase Overcurrent plus earth fault	MAPro 107 3phase overcurrent plus earth fault	MAPro 101 Single phase overcurrent	MAPro 102 earth fault overcurrent	MAPro 103 sensitive earth fault overcurrent
Single phase overcurrent	50/51				X		
Earth fault overcurrent	50N/51N					X	
Sensitive earth fault overcurrent	64N						X
3 phase overcurrent + earth fault	50/51/50N/51N	X	X	X			
Undercurrent detection with blocking logic	37	X	X	X			
Single phase trip output facility (phase distinction in phase O.C. trip)			X				
Negative sequence overcurrent	46	X	X				
Latching output contacts	86	X	X	X	X	X	X
Broken conductor detection		X	X				
Cold load pick up		X	X				
Trip circuit supervision		X	X				
Multi shot auto reclose	79	X	X (Internal/External trigger)				
Setting groups		2	2	2	2	2	2
Selective relay & input scheme logic		X	X	X	X	X	X
Circuit Breaker Control			X				
Thermal Overload	49		X				
AND/OR logic in phase O.C.		X	X	X			
True RMS & Negative & positive seq. measurement		X	X	X			
Inrush Restrain		X	X	X	X	X	X
Event records		X	X	X	X	X	X
Fault records		X	X	X	X	X	X
Disturbance records		X	X (flexible duration)	X	X	X	X
Communication protocol		Modbus	IEC60870-5-103/Modbus by order	Modbus	Modbus	Modbus	Modbus
Rear RS485 & front USB communication		X	X	X	X	X	X
No. of digital inputs		5	5/9	2	2	2	2
No. of output relays		8+1(for WD)	8+1(for WD)	5+1(for WD)	4+1(for W.D.)	4+1(for W.D.)	4+1(for W.D.)
Over current blocking logic			X				
Auto reclose active on fault detection			X				
Input/output/LED label define & monitoring			X				

I – 4: Installation

1- Unscrew the upper & lower nuts at the front of relay.

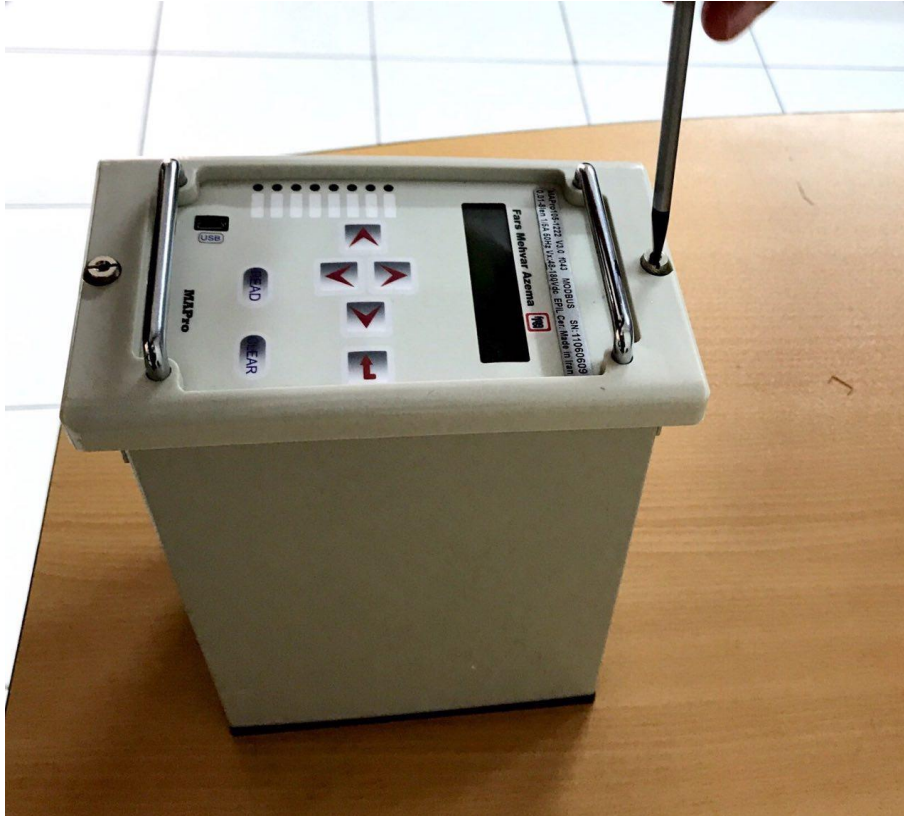

2 - Remove fixative clamps from back Phoenix terminals

3 - Remove Phoenix female terminals

4 - Withdraw the relay from its case.

5 - Unscrew the Earth screw at the back of relay case.



6- Fix the relay case on the panel and fasten the screws then put & fix the relay in its case. Fasten the front upper & lower nuts, put female green connectors, and after wiring, put and fasten fixative clamps & back earth connection screw.



T: Technical Data & Function Characteristics

T – 1 Protection Functions

T-1.1 – Phase over current:

- Phase current setting range: 0.1 to $25I_n$ step of $0.01I_n$
- Thresholds: 3 independent levels, $I>$, $I>>$, $I>>>$
- $I>$ setting range: 0.1 to $25I_n$
- $I>>$ setting range: 0.1 to $25I_n$
- $I>>>$ setting range: 0.1 to $25I_n$

Note: When $I>$ or $I>>$ threshold is associated to an IDMT curve, it is recommended to set it to max value of $2I_n$.

Note: $I>>>$ threshold can only be assigned to DMT operation.

- Hysteresis: 95%
- Shortest operation time: <40 mSec (Instantaneous operation)
- Drop out time: <60 mSec (If reset time = 0)
- Definite time delay (for trip & reset): 0 to 600 Sec step of 0.01 Sec
- IDMT curves for trip: IEC:
 - Short time Inverse (STI)
 - Standard Inverse (SI)
 - Very Inverse (VI)
 - Extremely Inverse (EI)
 - Long Time Inverse (LTI)
- IEEE:
 - Moderately Inverse (IMI)
 - Very Inverse (IVI)
 - Extremely Inverse (IEI)
- IDMT curves for reset (optional):
 - Standard Inverse (SI)
 - Very Inverse (VI)
 - Extremely Inverse (EI)

- Time multiplier setting: Trip: 0.01 to 1.5 step of 0.01
- Reset (optional): 0.01 to 3.2 step of 0.01

T-1.2 – Neutral/Earth fault over current protection

- Earth current setting range: 0.01 to $8I_n$ step of $0.01I_n$
- Thresholds: 3 independent levels, $I_{e>}$, $I_{e>>}$, $I_{e>>>}$
- $I_{e>}$ setting range: 0.01 to $8I_{en}$ step of 0.01
- $I_{e>>}$ setting range: 0.01 to $8I_{en}$ step of 0.01
- $I_{e>>>}$ setting range: 0.01 to $8I_{en}$ step of 0.01

Note: When $I_{e>}$ or $I_{e>>}$ threshold is associated to an IDMT curve, it is Recommended to set it to Max value of $2I_{en}$.

Note: $I_{e>>>}$ threshold can only be assigned to DMT operation.

- Hysteresis: 95%
- Shortest operation time: <40 mSec (Instantaneous operation)
- Drop out time: <60 mSec
- Definite time delay (for trip & reset): 0 to 600 Sec step of 0.01 Sec
- IDMT curves for trip: IEC:
 - Short time Inverse (STI)
 - Standard Inverse (SI)
 - Very Inverse (VI)
 - Extremely Inverse (EI)
 - Long Time Inverse (LTI)
- IEEE:
 - Moderately Inverse (IMI)
 - Very Inverse (IVI)
 - Extremely Inverse (IEI)
- IDMT curves for reset (optional):
 - Standard Inverse (SI)
 - Very Inverse (VI)
 - Extremely Inverse (EI)

- Time multiplier setting: Trip: 0.01 to 1.5 step of 0.001
- Reset (optional): 0.01 to 3.2 step of 0.001

T-1.3 – Sensitive Earth fault over current protection

- Earth current setting range: 0.005 to $2.5I_{en}$ step of $0.001I_n$
- Thresholds: 3 independent levels, $I_{se>}$, $I_{se>>}$, $I_{se>>>}$
- $I_{se>}$ setting range: 0.005 to $2.5I_{en}$ step of 0.001
- $I_{se>>}$ setting range: 0.005 to $2.5I_{en}$ step of 0.001
- $I_{se>>>}$ setting range: 0.005 to $2.5I_{en}$ step of 0.001

Note: When $I_{se>}$ or $I_{se>>}$ threshold is associated to an IDMT curve, it is recommended to set it to Max value of $2I_{en}$.

Note: $I_{se>>>}$ threshold can only be assigned to DMT operation.

- Hysteresis: 95%
- Shortest operation time: <40 mSec (Instantaneous operation)
- Drop out time: <60 mSec
- Definite time delay (for trip & reset): 0 to 600 Sec step of 0.01 Sec
- IDMT curves for trip: IEC:
 - Short time Inverse (STI)
 - Standard Inverse (SI)
 - Very Inverse (VI)
 - Extremely Inverse (EI)
 - Long Time Inverse (LTI)
- IEEE:
 - Moderately Inverse (IMI)
 - Very Inverse (IVI)
 - Extremely Inverse (IEI)
- IDMT curves for reset (optional):
 - IEEE Moderately Inverse (IMI)
 - IEEE Very Inverse (IVI)
 - IEEE Extremely Inverse (IVI)

- Time multiplier setting: Trip: 0.01 to 1.5 step of 0.001
- Reset (optional): 0.01 to 3.2 step of 0.001

T-1.4 – Under current protection

- Phase under current setting range($I<$): 0.02 to $1I_n$ step of 0.01
- Time delay setting range: 0 to 150 Sec step of 0.01 Sec
- Hysteresis: 105%
- Blocking facility: 1- By digital inputs, 1 or 2 or both
2- By threshold, range: 0 – 10 I_n step of 0.1 I_n

T – 2: Recording

T-2.1 – Event recording

- Capacity: 75 events (saved in log memory)
- Event types: Any change in settings
Change in state of digital inputs
Automation function alarms
Pick up
- Data: Event label + date & time (accuracy: 10mSec)

T-2.2 – Fault recording

- Capacity: 10 faults (saved in log memory)
- Fault types: Any selected protection trip or alarm
- Data: Protection label
AC measurements (3 phase & earth RMS)
Fault magnitude
Fault date & time (time accuracy: 10 mSec)

Also faults can be observed via front display by pressing “READ” key and scrolling faults by “up” & “down” keys. Events and faults are recorded in txt format.

The accordance of the event and fault files with the original generated ones can be checked by “CRC check” tab in PC software.

T-2.3– Disturbance recording

- Capacity: 10 records (saved in log memory)
- Record sampling rate: 16 samples/cycle
- Pre fault time: 0.2 – 3 sec (10 - 150 cycles) step of cycle (20ms)
- post fault time: 0.2 – 5 sec (10 - 250 cycles) step of cycle (20ms)
- Data: According to Com trade format
- Trigger: Pick up or trip

Along with disturbance data, another file can be received which contains the state of inputs & outputs, configured for different protections.

Disturbance files can be received via front USB port by MAPro setting PC Software or communication protocol.

The screenshot displays the MAPro10 Rev 30 (OFFLINE MODE) software interface. The main window is titled "MAPro10 Rev 30 (OFFLINE MODE)" and features a menu bar with options: Measurement, Settings, I>, I>>, I>>>, IE>, IE>>, IE>>>, I2>, I<, A.R, Inrush, TCS, CLP, B.C, Logic, C.B. Ctrl. The interface is divided into several sections:

- Configurations:**
 - CT Ratio:** PH Prim (A) 1000, CT PH Sec 1A, E Prim (A) 1000, CT E Sec 1A.
 - Group Selection:** RMS/FFT FFT, Active group Group 1.
 - Under Block Config:** UBLK Level 5.0, UBLK LED LED Off.
 - Under Block Input:** Radio buttons for None (selected), One Input, Two Input.
 - Other Config:** Pickup Relay Relay Off, Remote Reset Off.
- Trip Alarm For Line:** Phase A, Phase B, Phase C. LED Off, Off, Off. Relay Off, Off, Off.
- Disturbance:** Pre-fault Record time (Cycle) 10, Post-fault Record time (Cycle) 250. Trigger at: Pickup, Trip.
- Info:** Name FMA, Serial 1234. Button: Get Setting from Relay.
- Communication:**
 - Address 1, Baud rate 9600, Parity None.
 - Buttons: Read Disturbance, Delete Disturbance, Identity Check, Export Calibration Factor, Read Events, Read Faults, Delete Event\Fault, Import Calibration Factor.
- Connection Matrix:** Buttons for Import Setting from PC, Export Setting to PC, Upload Setting to Relay.

At the bottom, a status bar indicates: "Setting has been imported successfully at 11:18:20".

T- 2.4 Time and date setting

The time and date of relay can be set and updated according to PC time and date by an option of PC software when relay is connected to laptop or can be updated via communication protocols (Modbus or IEC60870-5-103).

The relay time and date can be observed on display by pressing “up” key when you are not in setting menus. By pressing “CLEAR” key you will return to main menu.

T- 2.5 Measurements monitoring:

Measurements, containing the following items, are shown on display via measurement menu:

- I_A (I_R), I_B (I_S), I_C (I_T) and I_e rms values.
- I_1 (positive sequence), and I_2 (negative sequence), rms values.
- I_2/I_1 ratio.
- $I_n - I_{fn}$ (true rms minus rms value of fundamental frequency).
(means the total rms value of harmonics).
- Max of I_A , I_B , I_C from the last resetting. Any time you can reset the Max values by pressing “up” key when you are observing any of them.
- Phase angle (Θ) of I_B and I_C related to I_A in degrees ($I_A = 0$).

T – 3: Communication

T- 3.1 RS485 (rear connector, twisted pair wire)

- Protocol: IEC60870-5-103/Modbus RTU
- Baud rate: 19200, 38400
- Connector: screw type/cable shoe
- Application: Transfer of information & remote programming

T- 3.2 USB (front connector)

- Connector: Mini USB standard connector
- Application: Information extraction & system programming by a local PC or laptop

T – 4 Inputs & outputs

T- 4.1 AC inputs

- Phase current inputs: 1A & 5A by connection (specified in setting)
- Earth current input: 1A & 5A by connection (specified in setting)
- Frequency: 50 Hz
- Burden:

phase:	<0.035VA for 1A input
	<0.4VA for 5A input
Earth:	<0.01VA for 1A input at 0.1A
	<0.05VA for 5A input at 0.5A
- Current thermal withstand:

1 Sec at $50I_n$
2 Sec at $25I_n$
Continuous at $4I_n$

T- 4.2 Logic inputs & outputs

- Logic inputs:

Independent optical isolated
Burden <10mA
Voltage range 35 to 150Vdc
Recognition time <5mSec
- Logic outputs:

Dry contacts
Contact ratings: AC max 10A/250V, 50W resistive, 25W
Inductive with L/R 40mSec
DC max 0.3A/135V, 40W L/R 30mSec
Contact operation time: <10mSec
Contact electrical & mechanical operate lifetime:
>100000 times (at rated load)

T- 4.3: Power supply

-Aux. voltage range: 60 to 180Vac/dc, 48 to 150Vdc for **MAPro107**
others by order

-Ripple: <8%

-Burden: 3W min, 6.8W max with all output relays energized.

T- 4.4: Accuracy

-O.C. thresholds: +/- 3% or 1mA whichever is greater

-Trip time: Definite time: +/-2%, min: 50mSec

Inverse curves: +/-5%

Accuracy tables related to operate & reset times

IEC curves						
Type of curve	Tripping time (in seconds) for TMS =1					
IEC	2 x I threshold			10 x I threshold		
	Nominal	Min	Max	Nominal	Min	Max
Accuracy	+/- 12.5 % for nominal tripping time or 50mSec. Whichever is greater			+/- 5 % for nominal tripping time or 50mSec. Whichever is greater		
STI	1.78	1.56	2	0.518	0.448	0.588
SI	10.03	8.78	11.28	2.971	2.822	3.119
VI	13.5	11.81	15.19	1.5	1.425	1.575
EI	26.67	23.33	30	0.808	0.738	0.878
LTI	120	105	135	13.33	12.667	14

IEEE curves						
Type of curve	Tripping time (in seconds) for TMS =1					
IEEE	2 x I threshold			10 x I threshold		
	Nominal	Min	Max	Nominal	Min	Max
Accuracy	+/- 12.5 % for nominal tripping time or 50mSec. Whichever is greater			+/- 5 % for nominal tripping time or 50mSec. Whichever is greater		
IMI	3.8032	3.3278	4.2786	1.2068	1.1465	1.2671
IVI	7.0277	6.1492	7.9062	0.6891	0.6191	0.7591
IEI	9.5215	8.3313	10.7117	0.4063	0.3363	0.4763

DMT Accuracy	+/- 1 % or +/-50mSec, whichever is greater
--------------	--

Reset time accuracy	+/- 1 % or +/-50mSec, whichever is greater
---------------------	--

Note: If IDMT operation is considered, for high threshold settings ($>15I_n$ for phase, $>5I_n$ for earth & $>1.4I_n$ for sensitive earth), and currents more than $2I_n$, the mentioned accuracy will not be completely valid because of saturation.

T- 4.5: Inverse time curves

-The mathematical inverse time relations are:

$$\text{STI:} \quad t = \frac{0.05}{\left(\frac{I}{I_s}\right)^{0.04} - 1}$$

$$\text{SI:} \quad t = \frac{0.14}{\left(\frac{I}{I_s}\right)^{0.02} - 1}$$

$$\text{VI:} \quad t = \frac{13.5}{\left(\frac{I}{I_s}\right) - 1}$$

$$\text{EI:} \quad t = \frac{80}{\left(\frac{I}{I_s}\right)^2 - 1}$$

$$\text{LTI:} \quad t = \frac{120}{\left(\frac{I}{I_s}\right) - 1}$$

$$\text{IMI:} \quad t = \frac{0.0515}{\left(\frac{I}{I_s}\right)^{0.02} - 1} + 0.114$$

$$\text{IVI:} \quad t = \frac{19.61}{\left(\frac{I}{I_s}\right)^2 - 1} + 0.491$$

$$\text{IEI:} \quad t = \frac{28.2}{\left(\frac{I}{I_s}\right)^2 - 1} + 0.1215$$

NOTE: In all above relations, TMS (Time Multiplier Setting) is supposed to be 1, else TMS should be multiplied by t.

NOTE: In above relations, t is trip time, I is the value of fundamental frequency of current at tripping time, and I_s is the threshold current setting.

T- 4.6 Inverse time curves for reset time (optional)

-The mathematical inverse time relations for reset are:

$$\text{IMI:} \quad t = \frac{4.85}{1 - \left(\frac{I}{I_s}\right)^2}$$

$$\text{IVI:} \quad t = \frac{21.6}{1 - \left(\frac{I}{I_s}\right)^2}$$

$$\text{IEI:} \quad t = \frac{29.1}{1 - \left(\frac{I}{I_s}\right)^2}$$

NOTE: In all above relations, TMS (Time Multiplier Setting) is supposed to be 1, else t should be multiplied by TMS.

T – 5: Ancillary(Automation) functions for protection

T-5.1 – Cold load pick up

When a feeder circuit breaker is closed in order to energize a load, the current levels that flow for a period of time following energizing, may be far greater than the normal load levels. Consequently, overcurrent settings that have been applied to provide overcurrent protection may not be suitable during this period of energizing (cold load), as they may initiate undesired tripping of the circuit breaker.

This scenario can be prevented with Cold Load Pickup (CLP) functionality.

The Cold Load Pick-Up (CLP) logic works by raising the overcurrent settings of selected stages, for the cold loading period. The CLP logic therefore provides stability, whilst maintaining protection during the start-up. This function acts upon all overcurrent and earth fault stages.

CLP operation occurs when the circuit breaker remains open for a time greater than **tcold** and is subsequently closed. CLP operation is applied after **tcold** and remains for a set time delay of **tclp** following closure of the circuit breaker. The status of the circuit breaker is provided either by means of the CB auxiliary contacts or by means of an external device via logic inputs. Whilst CLP operation is in force, the CLP settings are enabled. After the time delay **tclp** has elapsed, the normal overcurrent settings are applied and the CLP settings are disabled.

- Range: 20 to 500% of nominal setting step of 1%
- Time delay (tclp): 0.1 to 3600 Sec step of 0.01 Sec
- Cold time (tcold): 0.1 to 3600 Sec step of 0.01 Sec(Optional)
- This function can be considered as a choice for each of the protections:

$I_1, I_2, I_3, I_4, I_5, I_6, I_7, I_8, I_9, I_{e1}, I_{e2}, I_{e3}, I_{e4}, I_{e5}, I_{e6}, I_{e7}, I_{e8}, I_{e9}, I_{2e}$

T-5.2 – Multi shot auto reclose

Introduction:

It is known that approximately 80 - 90% of faults are transient in nature. This means that most faults do not last long and are self-clearing. A common example of a transient fault is an insulator flashover, which may be caused for example by lightning, clashing conductors or wind-blown debris. A transient fault, such as an insulator flashover, is a self-clearing 'non-damage' fault. The flashover will cause one or more circuit breakers to trip, but it may also have the effect of clearing the fault. If the fault clears itself, the fault does not recur when the line is re-energized. The remaining 10 – 20%

of faults are either semi-permanent or permanent. A small tree branch falling on the line could cause a semi-permanent fault. Here the cause of the fault would not be removed by the immediate tripping of the circuit, but could be burnt away during a time-delayed trip. Permanent faults could be broken conductors, transformer faults, cable faults or machine faults, which must be located and repaired before the supply can be restored.

In the majority of fault incidents, if the faulty line is immediately tripped out, and time is allowed for the fault arc to deionize, reclosing of the circuit breakers will result in the line being successfully re-energized.

Auto reclose schemes are used to automatically reclose a circuit breaker a set time after it has been opened, due to operation of a protection element. On HV/MV distribution networks, auto reclosing is applied mainly to radial feeders, where system stability problems do not generally arise.

The main advantages of using auto reclose are:

- Minimal interruption in supply to the consumer
- Reduction of operating costs - fewer man hours in repairing fault damage and the possibility of running unattended substations
- With Auto reclose, instantaneous protection can be used which means shorter fault durations. This in turn means less fault damage and fewer permanent faults. *(This advantage is optional and should be requested by customer.)*

Auto reclosing provides an important benefit on circuits using time-graded protection, in that it allows the use of instantaneous protection to provide a high speed first trip. With fast tripping, the duration of the power arc resulting from an overhead line fault is reduced to a minimum. This lessens the chance of damage to the line, which might otherwise cause a transient fault to develop into a permanent fault.

Using instantaneous protection also prevents blowing of fuses in teed feeders, as well as reducing circuit breaker maintenance by eliminating pre-arc heating.

When instantaneous protection is used with auto reclosing, the scheme is normally arranged to block the instantaneous protection after the first trip. Therefore, if the fault persists after re-closure, the time-graded protection will provide discriminative tripping resulting in the isolation of the faulted section. However, for certain applications, where the majority of the faults are likely to be transient, it is common practice to allow more than one instantaneous trip before the instantaneous protection is blocked.

Some schemes allow a number of re-closures and time-graded trips after the first instantaneous trip, which may result in the burning out and clearance of semi-permanent faults. Such a scheme may also be used to allow fuses to operate in teed feeders where the fault current is low. When considering feeders that are partly overhead line and partly underground cable, any decision to install auto-reclosing should be subject to analysis of the data (knowledge of the frequency of transient faults). This is because this

type of arrangement probably has a greater proportion of semi-permanent and permanent faults than for purely overhead feeders. In this case, the advantages of auto reclosing are small. It can even be disadvantageous because re-closing on to a faulty cable is likely to exacerbate the damage.

-Main shots: 1 to 4 selectable independent shots

- This function can be considered as a choice for each of the protections, $I_{>}, I_{>>}, I_{>>>}, I_{e>}, I_{e>>}, I_{e>>>}$

- A.R. Timers:

-Dead times (D1, D2, D3, D4): 0.01 to 600 Sec step of 0.01 Sec

-Reclaim time: 0.01 to 900 Sec step of 0.01 Sec

- CBR time, the time that A.R. will wait for C.B. to become ready if this input is "1" at the time of close order, otherwise A.R. will be locked out 0.01 – 600 step of 0.01

- Inhibit time, the time that starts at manual close time, and during this time, A.R. is not active: 0 – 3600 sec. step of 1

- A.R. Input designations:

- Input for C.B. 52a contact (1, if breaker is ON & 0, if breaker is OFF)

- Input for C.B. ready (1, if C.B. is ready for close & 0, if C.B. is not ready for close)

- External control input for A.R. activation

- Input for manual C.B. close detection, used for inhibit time start

(0→1 when C.B. is manually closed)

- Input for external A.R. protection trip (External trigger of A.R. , Only in MAPro10x/T2 version)

- A.R. signals (LED):

- A.R. in progress, becomes "ON" when A.R. is triggered and continues to be "ON" until "A.R. successful" or "A.R. locked out" signals become activated.

- A.R. successful, becomes "ON" when after reclosing, during reclaim time, no trip is happened, and A.R. steps are finished successfully

- A.R. locked out, becomes "ON" at following cases:

A.R. cannot be continued because C.B. isn't ready during CBR time.

A.R. cannot be continued because other required conditions are not available, such as 52a condition.

Trip is happened during last reclaim time.

- A.R. output contacts:

- A.R. close command, contact
- A.R. in progress, contact & LED
- A.R. successful, contact & LED
- A.R. locked out, contact & LED

MAPro10 Rev 30 (OFFLINE MODE)

Measurement Settings I> I>> I>>> IE> IE>> IE>>> I2> I< A.R. Inrush TCS CLP B.C. Logic C.B. Ctrl

Code: 79

Active Group 1

<input checked="" type="checkbox"/> Active	ARTripBy	Input 52a	CYCL	ReClm(s)	Input EXT	Input CBR	Input IHB	AR Active for:	Relays
<input checked="" type="checkbox"/> EXT Control	Internal	1	4	0.01	2	3	4	<input type="checkbox"/> I> <input type="checkbox"/> Ie>	<input type="checkbox"/> 1 <input type="checkbox"/> 3 <input type="checkbox"/> 5 <input type="checkbox"/> 7
<input checked="" type="checkbox"/> CB Ready		D1 (s)	D2 (s)	D3 (s)	D4 (s)	CBR(s)	IHB(s)	<input type="checkbox"/> I>> <input type="checkbox"/> Ie>>	<input type="checkbox"/> 2 <input type="checkbox"/> 4 <input type="checkbox"/> 6 <input type="checkbox"/> 8
<input checked="" type="checkbox"/> Inhibit time		0.01	0.01	0.01	0.01	0.01	0	<input type="checkbox"/> I>>> <input type="checkbox"/> Ie>>>	Progress Success Lockout
									LED Off Off Off
									Relay Off Off Off

Active Group 2

<input checked="" type="checkbox"/> Active	ARTripBy	Input 52a	CYCL	ReClm(s)	Input EXT	Input CBR	Input IHB	AR Active for:	Relays
<input checked="" type="checkbox"/> EXT Control	External	1	4	0.01	2	3	4	<input type="checkbox"/> I> <input type="checkbox"/> Ie>	<input type="checkbox"/> 1 <input type="checkbox"/> 3 <input type="checkbox"/> 5 <input type="checkbox"/> 7
<input checked="" type="checkbox"/> CB Ready		D1 (s)	D2 (s)	D3 (s)	D4 (s)	CBR(s)	IHB(s)	<input type="checkbox"/> I>> <input type="checkbox"/> Ie>>	<input type="checkbox"/> 2 <input type="checkbox"/> 4 <input type="checkbox"/> 6 <input type="checkbox"/> 8
<input checked="" type="checkbox"/> Inhibit time	5	0.01	0.01	0.01	0.01	0.01	0	<input type="checkbox"/> I>>> <input type="checkbox"/> Ie>>>	Progress Success Lockout
									LED Off Off Off
									Relay Off Off Off

Connection Matrix

Import Setting from PC Export Setting to PC Upload Setting to Relay

Setting has been imported successfully at 11:18:20

T-5.3 - Trip circuit supervision & circuit breaker fail detection

Almost, the trip circuit extends beyond the relay enclosure and passes through components such as links, relay contacts, auxiliary switches and other terminal boards. Such complex arrangements may require dedicated schemes for their supervision.

There are two distinctly separate parts to the trip circuit; the trip path, and the trip coil. The trip path is the path between the relay enclosure and the CB cubicle. This path contains supporting components such as cables, fuses and connectors. A break in this path is possible, so it is desirable to supervise this trip path and to raise an alarm if a break should appear in this path.

The trip coil itself is also part of the overall trip circuit, and it is also possible for the trip coil to develop an open-circuit fault.

Trip Circuit Supervision scheme1 as an example:

In this scheme, only the 52a auxiliary contact is available. Relay monitors the trip coil, whatever the CB status is (CB open or CB closed).

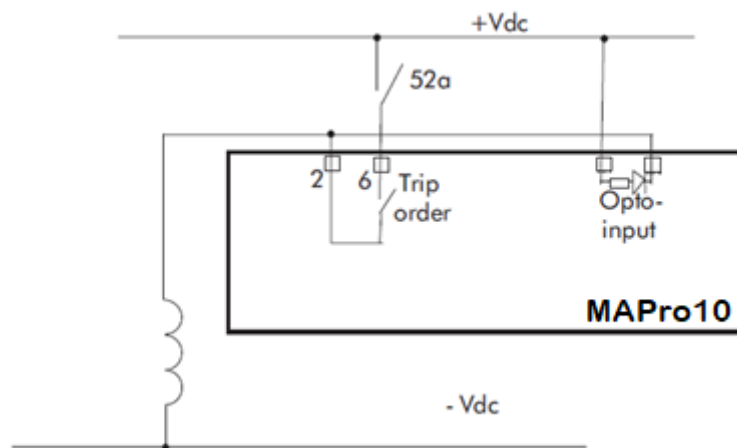

TCS scheme, example1

Trip Circuit Supervision scheme2 as an example:

In this example both 52a and 52b auxiliary contacts are available; the relay monitors the complete trip circuit when the CB is closed and a part of the trip circuit when the CB is open.

In this case it is necessary to insert a resistor R1 in series with 52b, if either the output (RL1) trip is latched or it stays involuntarily closed, or a long time trip pulse is programmed.

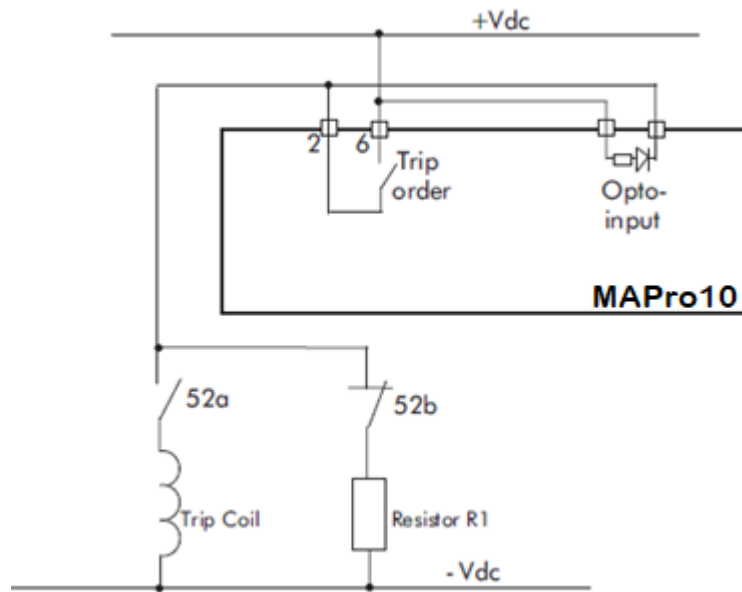

TCS scheme, example2

Trip Circuit Supervision scheme3 as an example:

In this example both 52a and 52b auxiliary contacts are available, the relay monitors the complete trip circuit whatever the CB status (CB open or CB closed). In this case it is necessary to insert an R1, if either the output (**RL1**) trip is latched, or it stays involuntarily closed, or a long time trip pulse is programmed.

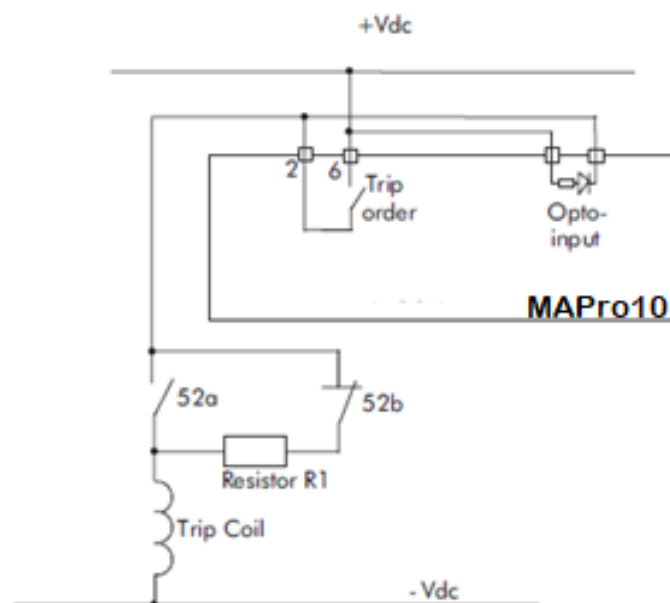

TCS scheme, example3

Related parameters:

-Circuit breaker operation time (for open & close): 0.02 to 1 sec Step of 0.01 Sec

(This time is respite time for CB to operate)

-Trip relay operation time considered in algorithm: max. 30 mSec

-One input for C.B.52a contact checking, selectable from 1 to 5 or 9 (Wired as schemes)

-One output relay selectable from 1 to 8, to announce TCS alarm, or C.B. operation fail with event recording.

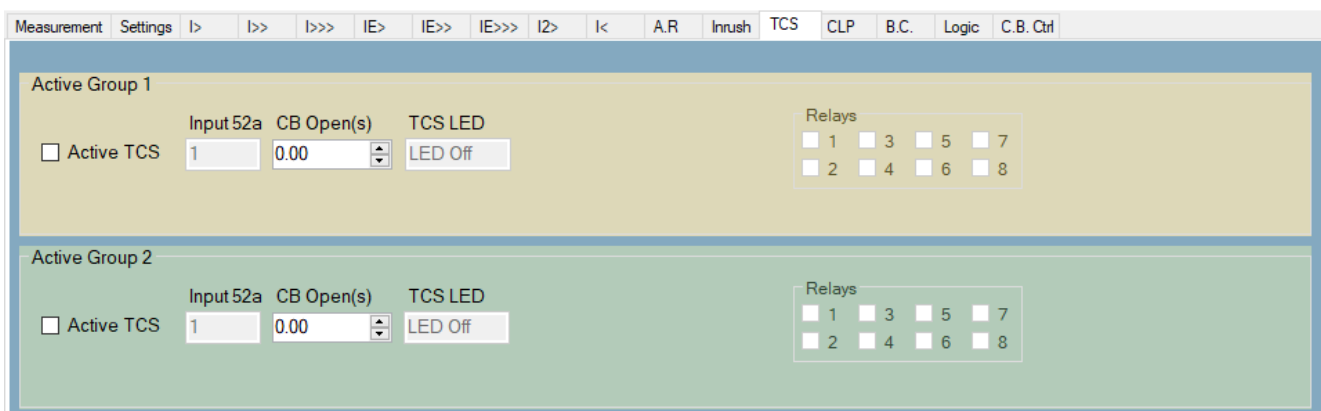

T-5.4 – Broken conductor detection:

Sometimes there is unbalance faults, caused by the 'Series' or 'Open Circuit' faults. This type of fault can arise from, broken conductors. Series faults do not cause an increase in phase current and so cannot be detected by overcurrent operations. However, they do produce an imbalance, resulting in negative phase sequence current, which can be detected.

It is possible to apply a negative phase sequence overcurrent element to detect broken conductors. However, on a lightly loaded line, the negative sequence current resulting from a series fault condition may be very close to, or less than, the full load steady state imbalance arising from CT errors and load imbalances, making it very difficult to distinguish. A regular negative sequence element would therefore not work at low load levels. To overcome this, the device incorporates a special Broken Conductor protection element.

The Broken Conductor element measures the ratio of negative to positive phase sequence current (I_2/I_1). This ratio is approximately constant with variations in load current, therefore making it more sensitive to series faults than standard negative sequence protection.

Related parameters:

-Broken conductor detection is based on calculation of I_2/I_1 (Based on fundamental frequency).

-Broken conductor threshold: 20% to 100% step of 1%

-Broken conductor time delay: 1 to 14400 Sec step of 1Sec

T-5.5 – Undercurrent protection:

In order to prevent damage/further damage to the power system due to loss of load, the under current protection is available in MAPro10x relays.

This may be caused by CB failure, or other line failures.

Under current function can be blocked by two ways:

- By an undercurrent threshold which is defined in configuration setting menu
- By two digital inputs which are defined in configuration menu. These inputs are combined together with **OR** logic.

Related parameters:

-Broken conductor detection is based on calculation of I_2/I_1 (Based on fundamental frequency).

-Under current threshold (As percent of nominal current): 2% to 255% step of 1%

-Under current time delay: 0 to 1000 Sec step of 0.01Sec

T-5.6 – Negative sequence over current protection:

When applying standard phase overcurrent protection, the overcurrent elements must be set significantly higher than the maximum load current, thereby limiting the element's sensitivity. Most protection schemes also use an earth fault element operating from residual current, which improves sensitivity for earth faults. However, certain faults may arise which can remain undetected by such schemes. Negative Sequence Overcurrent elements can be used in such cases. Any unbalanced fault condition will produce a negative sequence current component. Therefore, a negative phase sequence overcurrent element can be used for both phase-to-phase and phase-to-earth faults.

Negative Sequence Overcurrent protection offers the following advantages:

- Negative phase sequence overcurrent elements are more sensitive to resistive phase-to-phase faults, where phase overcurrent elements may not operate.
- In certain applications, residual current may not be detected by an earth fault element due to the system configuration. For example, an earth fault element applied on the delta side of a delta-star transformer is unable to detect earth faults on the star side. However, negative sequence current will be present on both sides of the transformer for any fault condition, irrespective of the transformer configuration. Therefore, a negative phase sequence overcurrent element may be used to provide time-delayed back-up protection for any uncleared asymmetrical faults downstream.
- Where rotating machines are protected by fuses, loss of a fuse produces a large amount of negative sequence current. This is a dangerous condition for the machine due to the heating effect of negative phase sequence current. An upstream negative phase sequence overcurrent element could therefore be applied to provide back-up protection for dedicated motor protection relays.
- It may be sufficient to simply trigger an alarm to indicate the presence of negative phase sequence currents on the system. Operators may then investigate the cause of the imbalance.

Measurement Settings > I> I>> IE> IE>> IE>>> I2> I< A.R. Inrush TCS CLP B.C. Logic C.B. Ctrl										Code: 50_2/51_2/46							
Active Group 1										Reset time settings				Relays			
<input type="checkbox"/> Active I2>										Function DMT Time(s) TMS				<input type="checkbox"/> 1 <input type="checkbox"/> 3 <input type="checkbox"/> 5 <input type="checkbox"/> 7 <input type="checkbox"/> 2 <input type="checkbox"/> 4 <input type="checkbox"/> 6 <input type="checkbox"/> 8 <input type="checkbox"/> Output latch			
Threshold		Function		DMT Time(s)		TMS		LED pick up		LED trip		DMT		DMT Time(s)		TMS	
1.00		SI		0.00		0.01		LED Off		LED Off		0.00		0.10			
Active Group 2										Reset time settings				Relays			
<input type="checkbox"/> Active I2>										Function DMT Time(s) TMS				<input type="checkbox"/> 1 <input type="checkbox"/> 3 <input type="checkbox"/> 5 <input type="checkbox"/> 7 <input type="checkbox"/> 2 <input type="checkbox"/> 4 <input type="checkbox"/> 6 <input type="checkbox"/> 8 <input type="checkbox"/> Output latch			
Threshold		Function		DMT Time(s)		TMS		LED pick up		LED trip		DMT		DMT Time(s)		TMS	
1.00		SI		0.00		0.01		LED Off		LED Off		0.00		0.10			

The negative phase sequence overcurrent element has a current pick up setting $I_{2>}$, and can be time-delayed using configurable timer(DMT or IDMT curves).

The current pick-up threshold $I_{2>}$ must be set to a value that is higher than the normal negative phase sequence current because of the normal unbalance conditions on the network. This can be done practically during the commissioning, using the “Measurement” menu of the relay to display the negative phase sequence current value. Then, this value has to be increased by 20%.

Where negative phase sequence element is used to clear particular cases of uncleared asymmetric faults, the threshold setting have to be calculated based on a fault analysis of that particular system, due to the complexities involved. However, to ensure that the protection element will operate, the current pick-up value has to be set to approximately 20% below the lowest calculated negative phase sequence fault current for a specific remote fault.

It is essential to set correctly the time delay associated to this function. It should also be noted that this element is used primarily as a back-up protection to other protective devices, or to provide an alarm. Therefore, this function is usually set with a long time delay (Mostly fixed delay time (Not IDMT) is suggested). Care must be made to ensure that the time delay is set above the operating time of any other protection device (at minimum fault level) present on the system and that may react to unbalanced faults, such as:

- Phase overcurrent elements
- Earth fault elements
- Broken conductor elements
- Negative phase sequence influenced thermal protection elements

When this function is operated, the waveforms and fault information of this function is also filed in disturbance and fault records

Related parameters:

- Current threshold setting range:	0.1 to $25I_n$
- IDMT curves for trip: IEC:	Short time Inverse (STI) Standard Inverse (SI) Very Inverse (VI) Extremely Inverse (EI)
IEEE:	Long Time Inverse (LTI) Moderately Inverse (IMI) Very Inverse (IVI)
-Time multiplier setting:	0.025 to 1.5 step of 0.001
-DMT:	0 to 150 Sec step of 0.01 Sec
-Reset time (definite):	0 to 100 Sec step of 0.01 Sec

T-5.7 – Inrush current restrain:

When a transformer is initially connected to a source of AC voltage, there may be a substantial surge of current through the primary winding called inrush current.

This is analogous to the inrush current exhibited by an electric motor that is started up by sudden connection to a power source, although transformer inrush is caused by a different phenomenon. In an ideal transformer, the magnetizing current would rise to approximately twice its normal peak value as well, generating the necessary MMF to create this higher-than-normal flux. However, most transformers are not designed with enough of a margin between normal flux peaks and the saturation limits to avoid saturating in a condition like this, and so the core will almost certainly saturate during this first half-cycle of voltage. During saturation, disproportionate amounts of MMF are needed to generate magnetic flux. This means that winding current, which creates the MMF to cause flux in the core, could rise to a value way in excess of its steady state peak value. Furthermore, if the transformer happens to have some residual magnetism in its core at the moment of connection to the source, the problem could be further exacerbated.

We can see that inrush current is a regularly occurring phenomenon and should not be considered a

fault, as we do not wish the protection device to issue a trip command whenever a transformer, or machine is switched on. This presents a problem to the protection device, because it should always trip on an internal fault. The problem is that typical internal transformer faults may produce over currents which are not necessarily greater than the inrush current. Furthermore faults tend to manifest themselves on switch on, due to the high inrush currents. For this reason, we need to find a mechanism that can distinguish between fault current and inrush current. Fortunately this is possible due to the different natures of the respective currents. An inrush current waveform is rich in harmonics, whereas an internal fault current consists only of the fundamental. We can thus develop a restraining method based on the harmonic content of the inrush current. The mechanism by which this is achieved is called second harmonic blocking.

The screenshot shows a software interface for configuring protection settings. At the top, there is a menu bar with various options: Measurement, Settings, I>, I>>, I>>>, IE>, IE>>, IE>>>, I2>, I<, A.R, Inrush, TCS, CLP, B.C., Logic, and C.B. Ctrl. Below the menu, there are two sections for 'Active Group 1' and 'Active Group 2'. Each section contains a table with three columns: 'Threshold(H2/H1)', 'Active Time(s)', and 'Input 52a'. The values for these columns are 40%, 3.00, and 1 respectively. To the right of each section is a group of checkboxes labeled 'Inrush Restrain Active for:' with options for I>, I>>, I>>>, IE>, IE>>, and IE>>>.

Related parameters:

- Threshold for ratio of second harmonic rms to fundamental frequency rms (H2/H1):

1% -100% step of 1

If H2/H1 becomes more than this threshold, during the active time, the selected protection functions are blocked.

- Inrush blocking active time: 0 – 3000 sec. step of 0.01sec
- Input for 52a: 1- 5 or 9
- protection function that should be affected by inrush blocking: I>, I>>, I>>>, IE>, IE>>, IE>>>, I2>

During the energizing period, the second harmonic component of the inrush current may be as high as 70%. The second harmonic level may be different for each phase, which is why phase segregated blocking is available.

If the setting is too low, the 2nd harmonic blocking may prevent tripping during some internal transformer faults. If the setting is too high, the blocking may not operate for low levels of inrush current which could result in undesired tripping of the overcurrent element during the energizing period. In general, a setting of 15% to 20% is suitable.

T-5.8 – Thermal over load protection:

The heat generated within an item of plant, such as a cable or a transformer, is the resistive loss (I^2Rt). The thermal time characteristic is therefore based on the square of the current integrated over time. The device automatically uses the largest phase current for input to the thermal model.

Equipment is designed to operate continuously at a temperature corresponding to its full load rating, where the heat generated is balanced with heat dissipated.

Over-temperature conditions occur when currents in excess of their maximum rating are allowed to flow for a period of time. It is known that temperature changes during heating follow exponential time constants.

$$t_{Tot} = \tau \ln \left(\frac{\left(\frac{I}{K \cdot I_N}\right)^2 - \left(\frac{I}{I_P}\right)^2}{\left(\frac{I}{K \cdot I_N}\right)^2 - 1} \right)$$

Where:

- t = time to trip, following application of the overload current I
- T = heating and cooling time constant of the protected plant
- I = largest phase current
- I_N = full load current rating (the Thermal Trip setting)
- K = Environmental constant
- I_p = steady state pre-loading current, before application of the overload

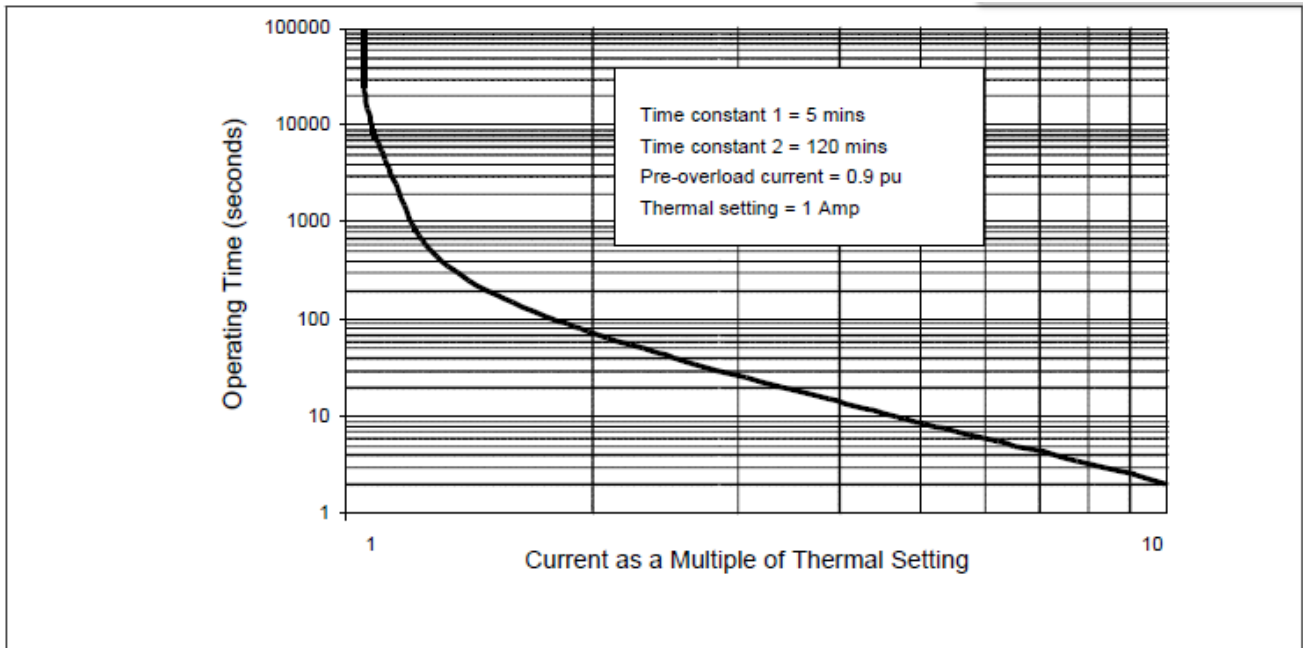

Typical thermal characteristic

It should be considered that current may be changed any time, after thermal over load pick up. So The time achieved from above relation cannot be valid at all times. In the relay algorithm, the current value is checked regularly, and if a notable change in current is seen, the time will be calculated with new values, and the initial thermal state also will be calculated from an exponential relation. Also after drop off, the reset time will be obtained from another logarithmic relation, in which the thermal state, before drop off is considered.

Related parameters:

$I_{e>}$:	Thermal current threshold, $0.1 - 3.2I_n$	step of 0.01
T:	Thermal time constant, $1 - 200$ minutes	step of 1 minute
k:	k factor, constant related to environment, $1-1.5$,	step of 0.01
Θ alarm	Thermal state alarm threshold	$50 - 200$ step of 1
Θ trip, if active,	Thermal state trip threshold	$50 - 200$ step of 1

T-5.9 – Circuit Breaker control:

Circuit Breaker control is only possible if the circuit breaker in question provides auxiliary contacts. The CB Status Input cell in the CB CONTROL menu must be defined ac Input for 52a of circuit breaker. For local control, the **CB control by** cell should be set to physical key.

The output contact can be set to operate following a time delay, during which the key is hold

pushed, defined by the setting **Hold time**. One reason for this delay is to avoid inadvertent operations and give personnel time to safely move away from the circuit breaker following a **CB close** command.

The length of the trip and close control pulses can be set via the **Pulse duration** which is for trip and close Pulses. These should be set long enough to ensure the breaker has completed its open or close cycle before the pulse has elapsed. If an attempt to close the breaker is being made, and a protection trip signal is generated, the protection trip command overrides the close command (The main protections have the most priority).

It is considered that two control logics, be used as interlocking during trip and close process separately, named **Logical limit in opening** and **Logical limit in closing**.

These inputs can be defined as **active high** or **Active low** and are combined by AND gate. After the operation is started at the end of trip or close pulse duration, relay respites CB to see its operation at 52a input change. The respite time is 500msec. If the CB fails to respond to the control command (indicated by no change in the state of 52a Status input) a **CB Failed to operate** alarm is written. This alarm can be viewed on the LCD display, or remotely.

The device includes the following options for control of a single circuit breaker:

- Local control using the physical keys
- Local control using opto-inputs
- Remote control using remote communication

The screenshot displays the configuration interface for two circuit breakers, labeled 'Active Group 1' and 'Active Group 2'. The interface is organized into several functional areas:

- Control Selection:** For each group, users can select the control method: Physical Key, Logic input, or Communication. A 'Change Password' button is also present.
- Operational Parameters:** Settings for 'Input for 52a', 'Hold Time' (set to 3.00), and 'Pulse Duration' (set to 0.10) are provided.
- Relay Configuration:** Each breaker has an 'Open LED' and 'Close LED' indicator, both currently set to 'Off'. There are also 8 relays (numbered 1-8) for both opening and closing operations.
- Logical Limits:** For both opening and closing, there are checkboxes for 'logical limit Active'. Below these are fields for 'First Input' and 'Second Input' (both set to 2), and dropdown menus for 'First Input Active' and 'Second Input Active' (both set to LOW).

T – 6: Ordering code:

MAPro10X X-XXXX → No of setting groups 1, 2

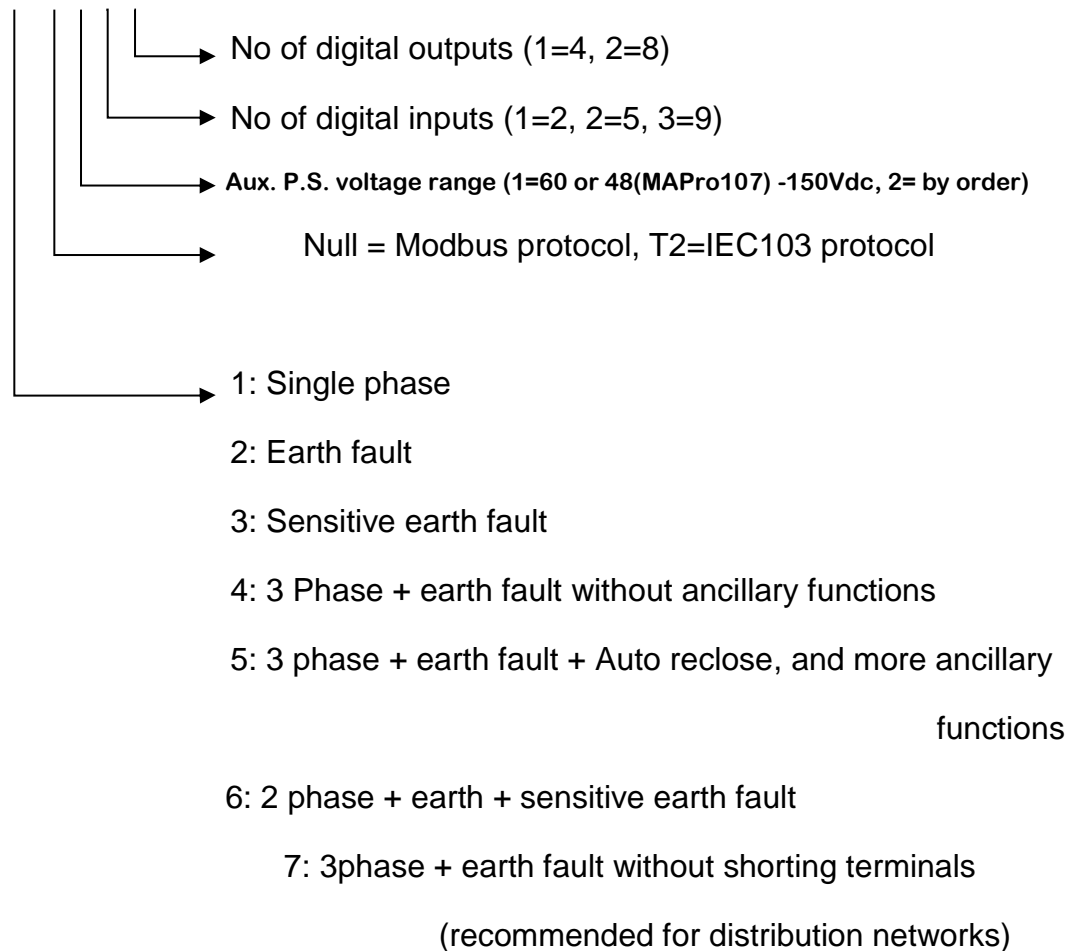

T – 7: Terminal blocks

T-7-1.0: General Terminal Block

One of the main features of the system is the withdrawable terminal block with up to 56 terminals, depending on relay features.

Back view of MPro1051222

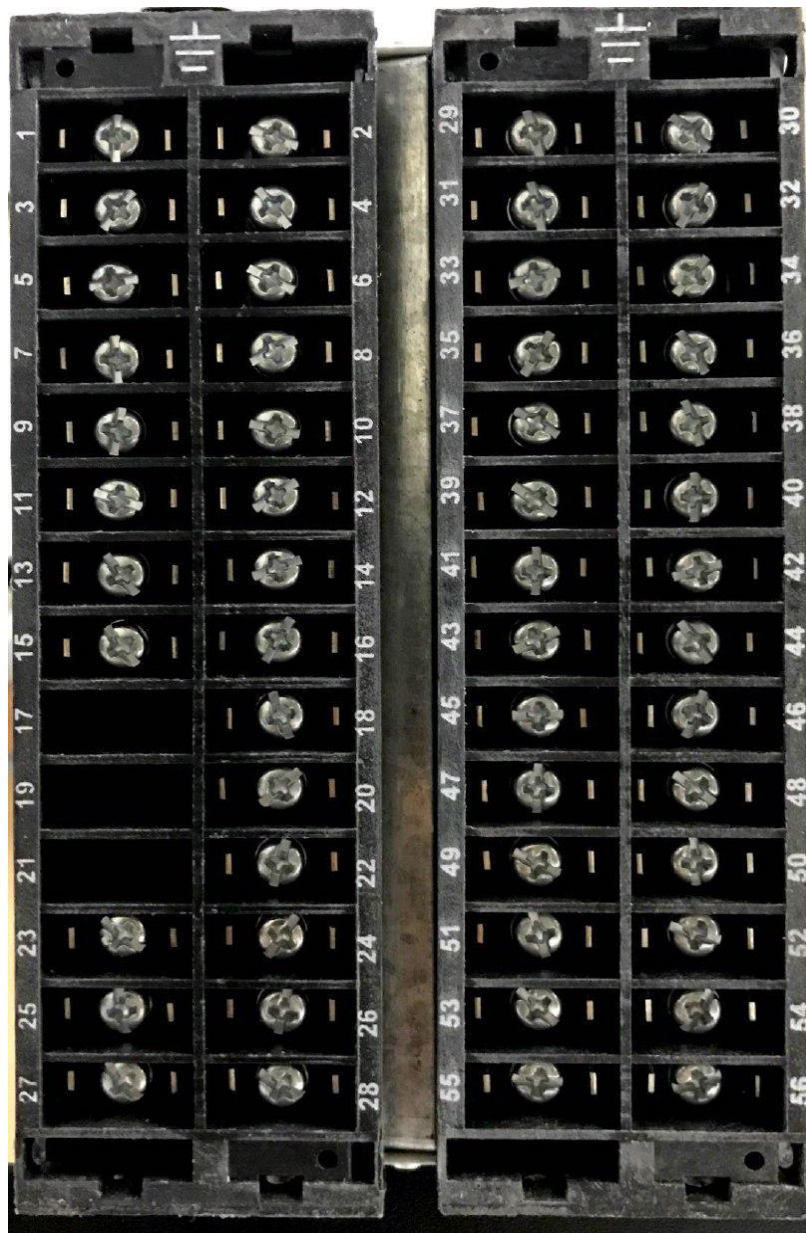

The polyamide used for terminal block is selected for its strength and flame retardant properties. It will withstand 5KV ac for 1 minute between terminals and earth, and 3.5 KV ac for 1 minute between adjacent terminals.

Individual terminals each provide a 4mm screw outlet suitable for accepting pre-insulated **'L' shaped (right angle) ring connectors** and two blades for accepting 4.8mm pre-insulated snap-on connectors. (Screw type connectors are recommended for connections specially for current inputs.)

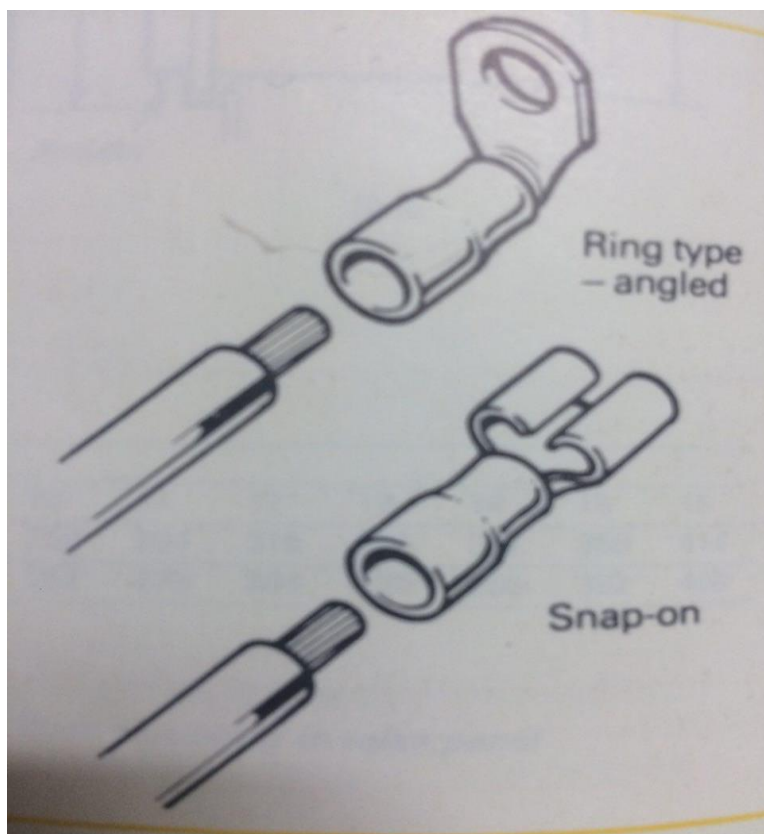

A very important benefit of this relay terminal block is that it is equipped with short circuiting devices at all current inputs, to automatically short circuit the current inputs whenever the module is withdrawn. (It is essential for CT safety)

The heavy duty terminals, used for current inputs are rated at 20A continuous & 400A for 1 second, and the others rated at 10A continuous & 200a for 1 second.

The earth connection of the relay is at upper side of 1st terminal block which is fixed with a 4mm screw to the inner earth blade of the case. *(Be sure that this connection with substation earth is established when relay is in service to avoid any disturbance in relay operation)*

T-7-1.1: General Terminal Block type1

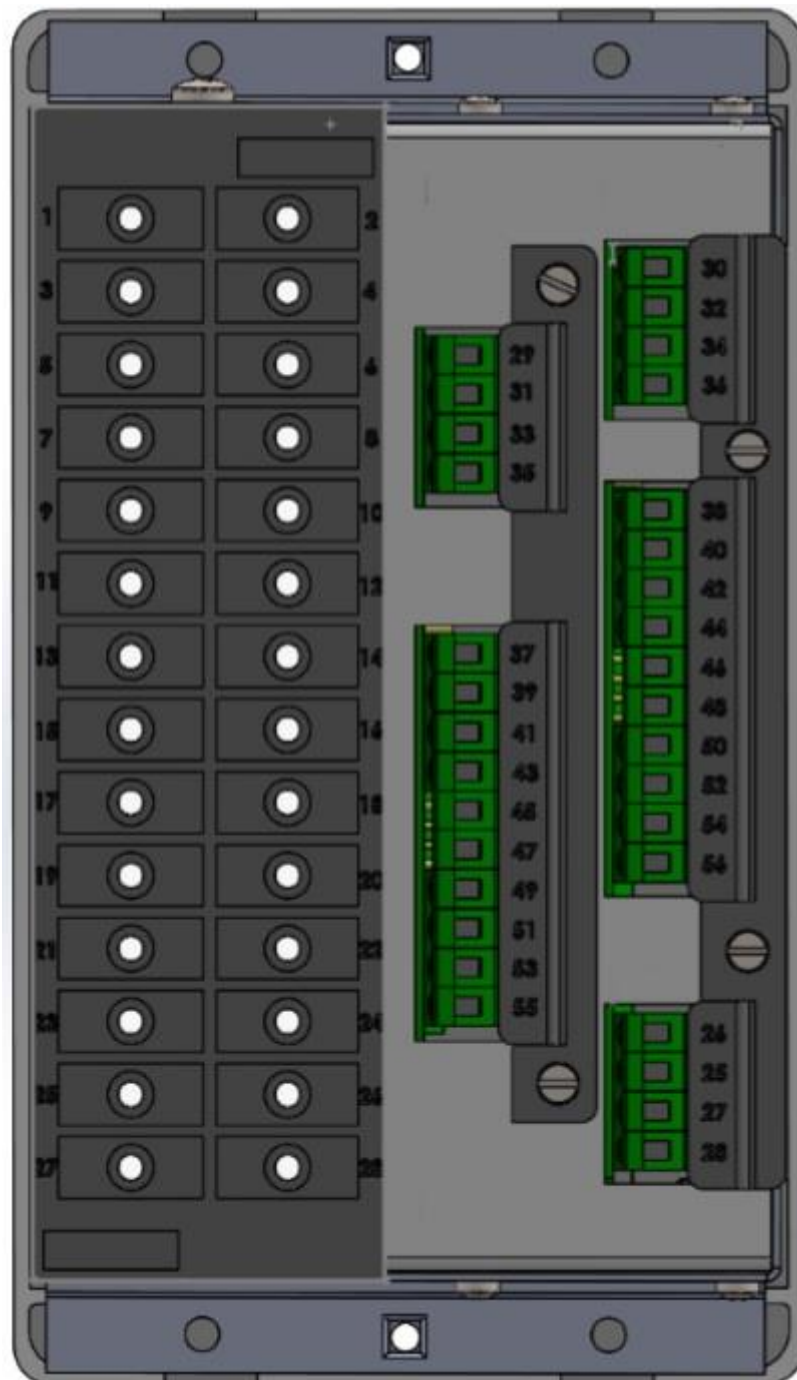

Back view of MPro1051222

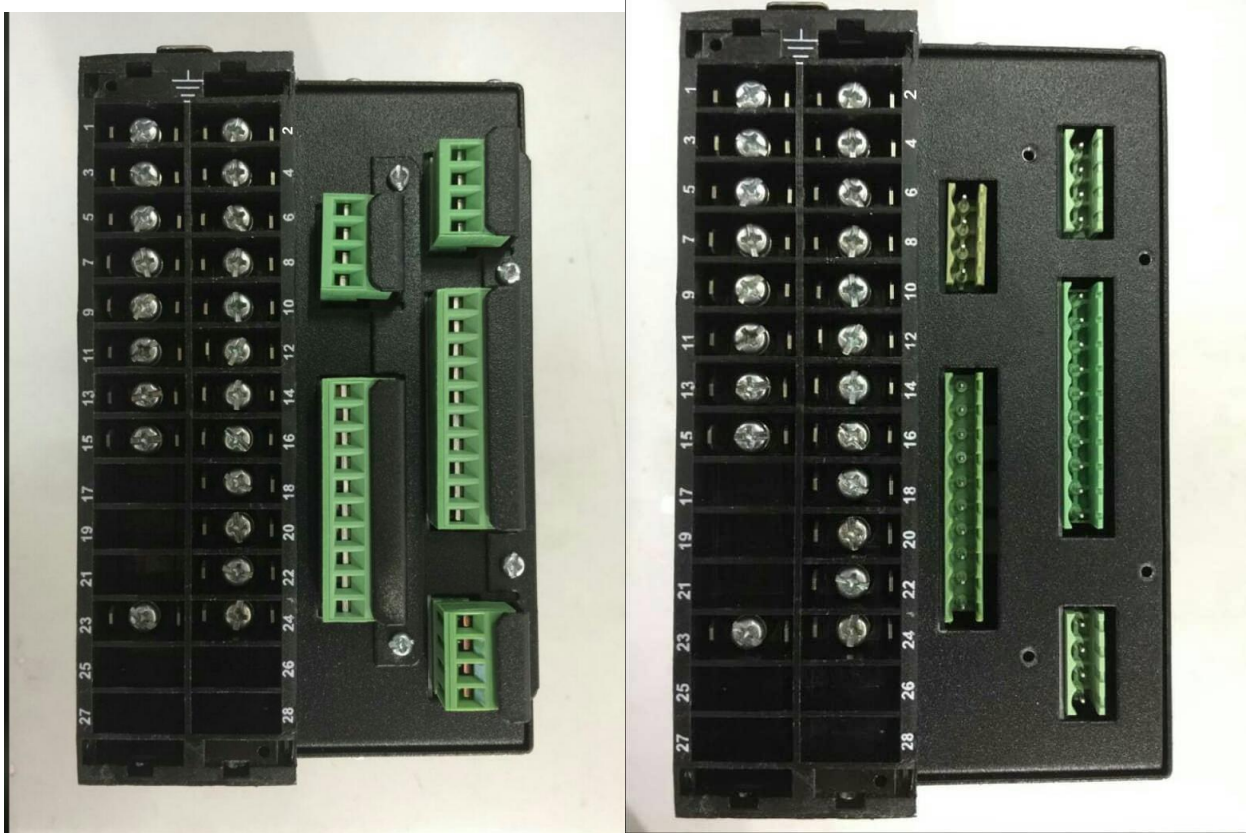

In this type, phoenix terminals are used, by the side of main FMA terminal. The main advantage of this type is easiness to pullout. This means that relay can be pulled out with less force, with successfully keeping the CT shorting performance.

Terminal numbers and their application are completely similar.

After installation and wiring is finished, the black clamps are considered to guarantee the secure establishing of green terminals. They should be fixed with related screws.

T – 7-2 : Terminal block for MPro107



T – 7-3: Connection guide for Mapro105 3ph+EF terminal

3Phase +Earth current relay terminal (5 input 8 output) Rev. 2				Back view			
Terminal No.	Description	Terminal No.	Description	Terminal No.	Description	Terminal No.	Description
1	1A Current input of phase A	2	1A Current input of phase A	29	Input 2	30	Input 5
3	1A Current input of phase B	4	1A Current input of phase B	31	Input 2	32	Input 5
5	1A Current input of phase C	6	1A Current input of phase C	33	input 1	34	Input 4
7	1A Current input of Earth	8	1A Current input of Earth	35	input 1	36	Input 4
9	5A Current input of phase A	10	5A Current input of phase A	37	Relay 4 N.O.	38	Input 3
11	5A Current input of phase B	12	5A Current input of phase B	39	Relay 4 COM	40	Input 3
13	5A Current input of phase C	14	5A Current input of phase C	41	Relay 3 N.O.	42	Relay 8 N.O.
15	5A Current input of Earth	16	5A Current input of Earth	43	Relay 3 COM	44	Relay 8 COM
17	Reserved	18	WD Relay COM	45	Relay 2 N.O.	46	Relay 7 N.O.
19	Reserved	20	WD Relay N.O.	47	Relay 2 N.C.	48	Relay 7 COM
21	Reserved	22	WD Relay N.C.	49	Relay 2 COM	50	Relay 6 N.O.
23	Aux power supply + input	24	Aux power supply - input	51	Relay 1 N.O.	52	Relay 6 COM
25	RS485 A	26	RS485 B	53	Relay 1 N.C.	54	Relay 5 N.O.
27	RS485 Ter. Res.	28	RS485 GND	55	Relay 1 COM	56	Relay 5 COM

T – 7-4: Connection guide for Mapro1051222/1041222, 3ph+EF terminal (type1)

1	1A current input of PhA	2	1A current input of PhA		
3	1A current input of PhB	4	1A current input of PhB		
5	1A current input of PhC	6	1A current input of PhC		
7	1A current input of PhE	8	1A current input of PhE		
9	5A current input of PhA	10	5A current input of PhA		
11	5A current input of PhB	12	5A current input of PhB		
13	5A current input of PhC	14	5A current input of PhC		
15	5A current input of PhE	16	5A current input of PhE		
17		18	W.D. rly Com		
19		20	W.D. rly N.O.		
21		22	W.D. rly N.C.		
23	Aux power sup.+	24	Aux power sup.-		
25		26			
27		28			

29	Input 2
31	Input 2
33	Input 1
35	Input 1

37	N.O. Rly4
39	Com. Rly4
41	N.O. Rly3
43	Com. Rly3
45	N.O. Rly2
47	N.C. Rly2
49	Com. Rly2
51	N.O. Rly1
53	N.C. Rly1
55	Com. Rly1

30	Input 5
32	Input 5
34	Input 4
36	Input 4

38	Input3
40	Input3
42	N.O. Rly8
44	Com. Rly8
46	N.O. Rly7
48	Com. Rly7
50	N.O. Rly6
52	Com. Rly6
54	N.O. Rly5
56	Com. Rly5

26	RS485 B(-)
25	RS485 A(+)
27	RS485 Ter R
28	RS485 GND

T – 7-5: Connection guide for Mapro105T2-1322, 3ph+EF terminal (type2)

1	1A current input of PhA	2	1A current input of PhA
3	1A current input of PhB	4	1A current input of PhB
5	1A current input of PhC	6	1A current input of PhC
7	1A current input of PhE	8	1A current input of PhE
9	5A current input of PhA	10	5A current input of PhA
11	5A current input of PhB	12	5A current input of PhB
13	5A current input of PhC	14	5A current input of PhC
15	5A current input of PhE	16	5A current input of PhE
17		18	W.D. rly Com
19		20	W.D. rly N.O.
21		22	W.D. rly N.C.
23	Aux power SUP _±	24	Aux power SUP _±
25		26	
27		28	

29	Input 2
31	Input 2
33	Input 1
35	Input 1

57	Input 6
58	Input 6
59	Input 7
60	Input 7
61	Input 8
62	Input 8
63	Input 9
64	Input 9
65	Not used
66	Not used

37	N.O. rly4
39	Com. Rly4
41	N.O. rly3
43	Com. Rly3
45	N.O. rly2
47	N.C. rly2
49	Com. Rly2
51	N.O. rly1
53	N.C. rly1
55	Com. Rly1

30	Input 5
32	Input 5
34	Input 4
36	Input 4

38	Input3
40	Input3
42	N.O. rly8
44	Com. Rly8
46	N.O. rly7
48	Com. Rly7
50	N.O. rly6
52	Com. Rly6
54	N.O. rly5
56	Com. Rly5

26	RS485 B(-)
25	RS485 A(+)
27	RS485 Ter R
28	RS485 GND

T – 7-6: Connection guide for Mapro1041112 3ph+EF terminal

3Phase +Earth current relay terminal (2 input 4 output) Rev. 2				Back view			
Terminal No.	Description	Terminal No.	Description	Terminal No.	Description	Terminal No.	Description
1	1A Current input of phase A	2	1A Current input of phase A	29	Input 2	30	
3	1A Current input of phase B	4	1A Current input of phase B	31	Input 2	32	
5	1A Current input of phase C	6	1A Current input of phase C	33	input 1	34	
7	1A Current input of Earth	8	1A Current input of Earth	35	input 1	36	
9	5A Current input of phase A	10	5A Current input of phase A	37	Relay 4 N.O.	38	
11	5A Current input of phase B	12	5A Current input of phase B	39	Relay 4 COM	40	
13	5A Current input of phase C	14	5A Current input of phase C	41	Relay 3 N.O.	42	
15	5A Current input of Earth	16	5A Current input of Earth	43	Relay 3 COM	44	
17	Reserved	18	WD Relay COM	45	Relay 2 N.O.	46	
19	Reserved	20	WD Relay N.O.	47	Relay 2 N.C.	48	
21	Reserved	22	WD Relay N.C.	49	Relay 2 COM	50	
23	Aux power supply + input	24	Aux power supply - input	51	Relay 1 N.O.	52	
25	RS485 A	26	RS485 B	53	Relay 1 N.C.	54	
27	RS485 Ter. Res.	28	RS485 GND	55	Relay 1 COM	56	

T – 7-7: Connection guide for Mapro107 3ph+EF terminal (recommended for distribution networks)

Black	Terminals	Green	Terminals
1	IA , 5A	17	Input 1
2	IA , 5A	18	Input 1
3	IB , 5A	19	Input 2
4	IB , 5A	20	Input 2
5	IC , 5A	21	RS485 B-
6	IC , 5A	22	RS485 A +
7	IE , 5A	23	RS485 GND
8	IE , 5A	24	Watchdog NC
9	IA , 1A	25	Watchdog NO
10	IA , 1A	26	Watchdog COM
11	IB , 1A	27	Relay 4 NC
12	IB , 1A	28	Relay 4 NO
13	IC , 1A	29	Relay 4 COM
14	IC , 1A	30	Relay 3 NO
15	IE , 1A	31	Relay 3 NC
16	IE , 1A	32	Relay 3 COM
		33	Relay 2 NO
		34	Relay 2 NC
		35	Relay 2 COM
		36	Relay 1 NO
		37	Relay 1 COM
		38	Relay 8 NO
		39	Relay 8 NC
		40	Relay 8 COM
		41	AUX
		42	AUX

T – 7-8: Connection guide for MAPro1021112/1031112 EF& SEF

Sensitive Earth Fault Relay (2 input 4 output) Rev. 2				Back view			
Terminal No.	Description	Terminal No.	Description	Terminal No.	Description	Terminal No.	Description
1		2		29	Input 2	30	Reserved
3		4		31	Input 2	32	Reserved
5		6		33	input 1	34	Reserved
7	1A Current input of Earth	8	1A Current input of Earth	35	input 1	36	Reserved
9		10		37	Relay 4 N.O.	38	Reserved
11		12		39	Relay 4 COM	40	Reserved
13		14		41	Relay 3 N.O.	42	Reserved
15	5A Current input of Earth	16	5A Current input of Earth	43	Relay 3 COM	44	Reserved
17	Reserved	18	WD Relay COM	45	Relay 2 N.O.	46	Reserved
19	Reserved	20	WD Relay N.O.	47	Relay 2 N.C.	48	Reserved
21	Reserved	22	WD Relay N.C.	49	Relay 2 COM	50	Reserved
23	Aux power supply + input	24	Aux power supply - input	51	Relay 1 N.O.	52	Reserved
25	RS485 A	26	RS485 B	53	Relay 1 N.C.	54	Reserved
27	RS485 Ter. Res.	28	RS485 GND	55	Relay 1 COM	56	Reserved

T – 8: Wiring diagrams for MPro104/105

T – 8.1 Phase current is given from 3 CTs & earth current from core balanced CT

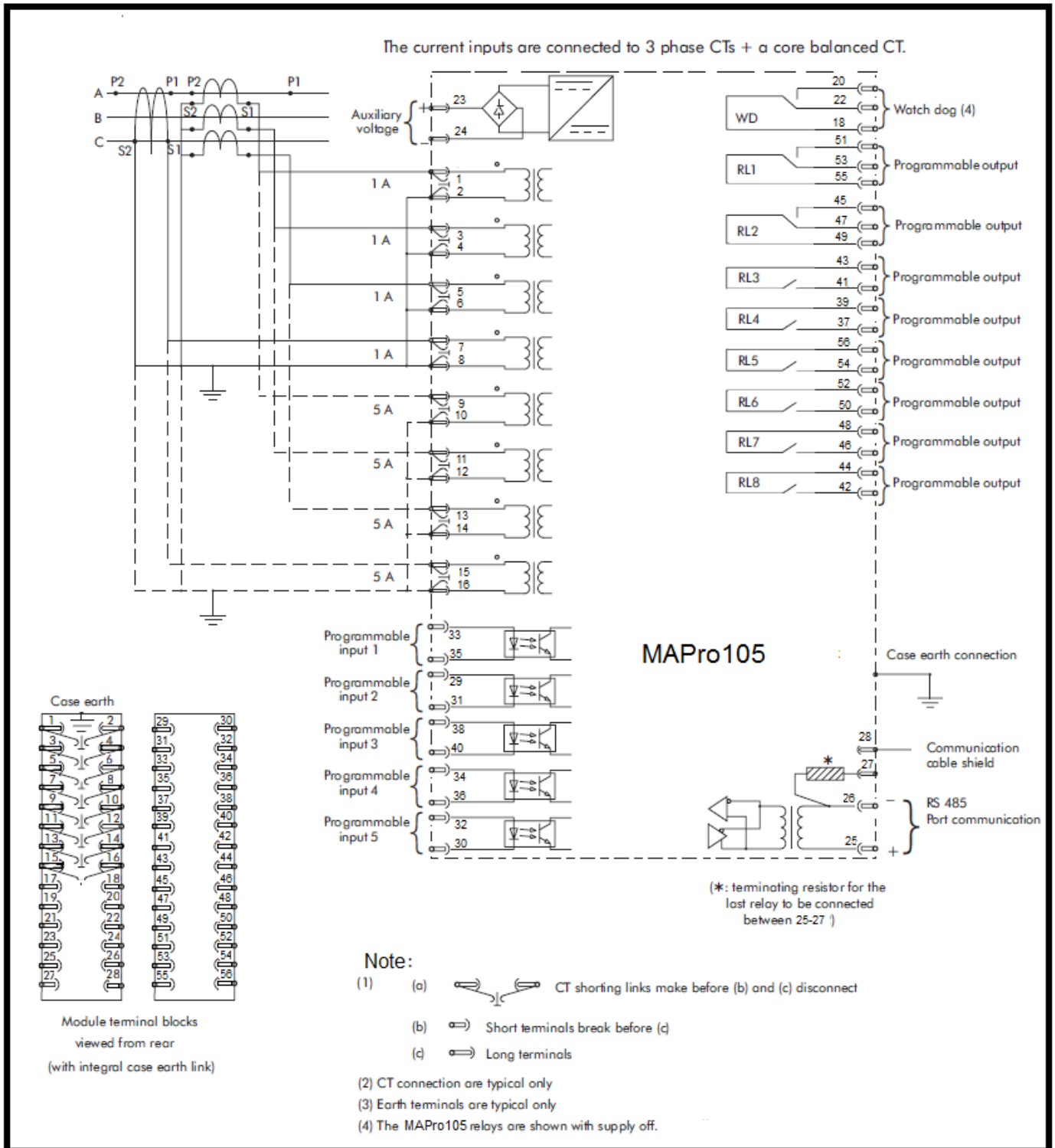

MAPro104/105/107 3 Phase Over current + Earth Fault Relay

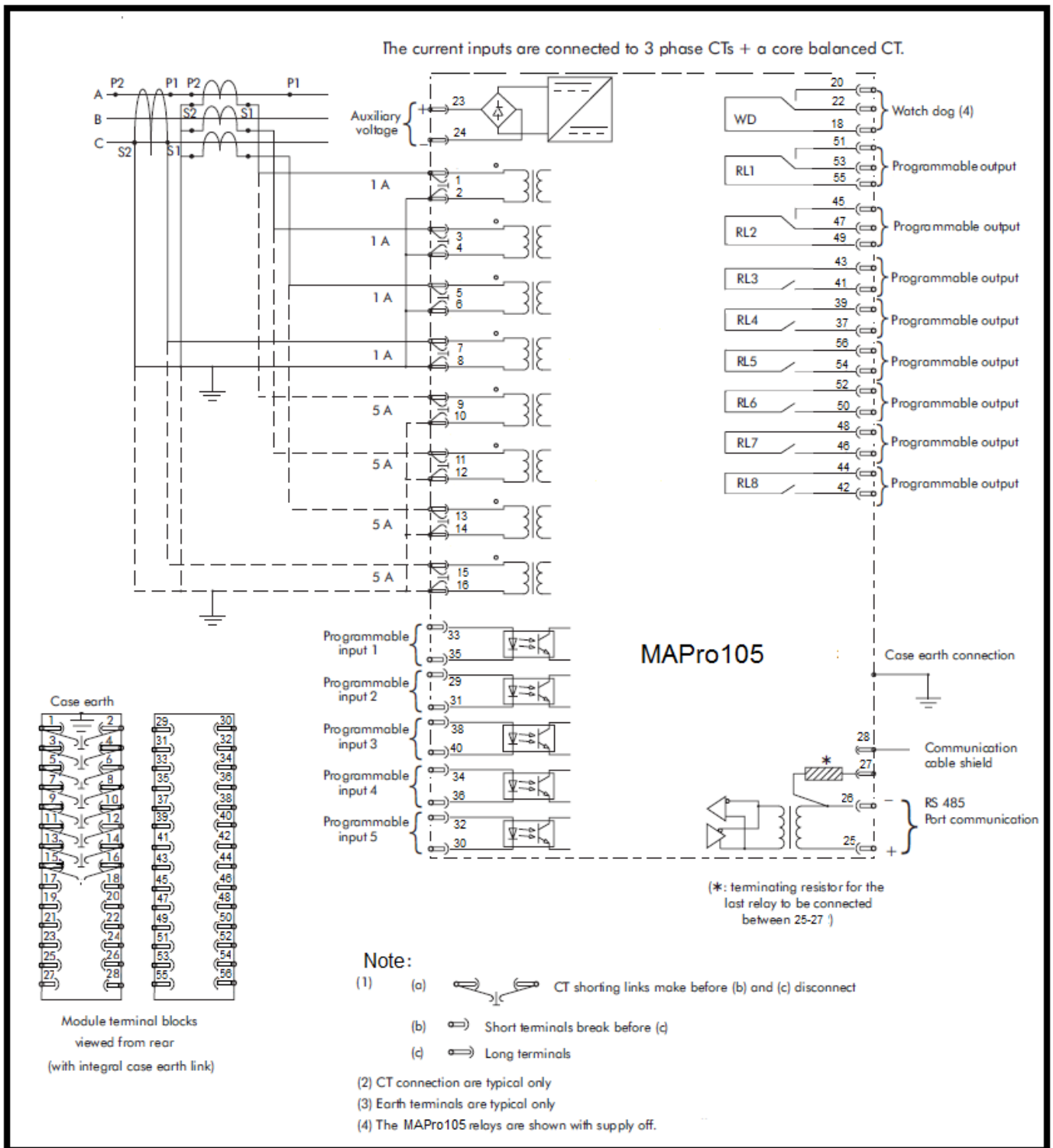

T – 8.2 Phase current is given from 3 CTs & earth current from summation of 3 phase CTs

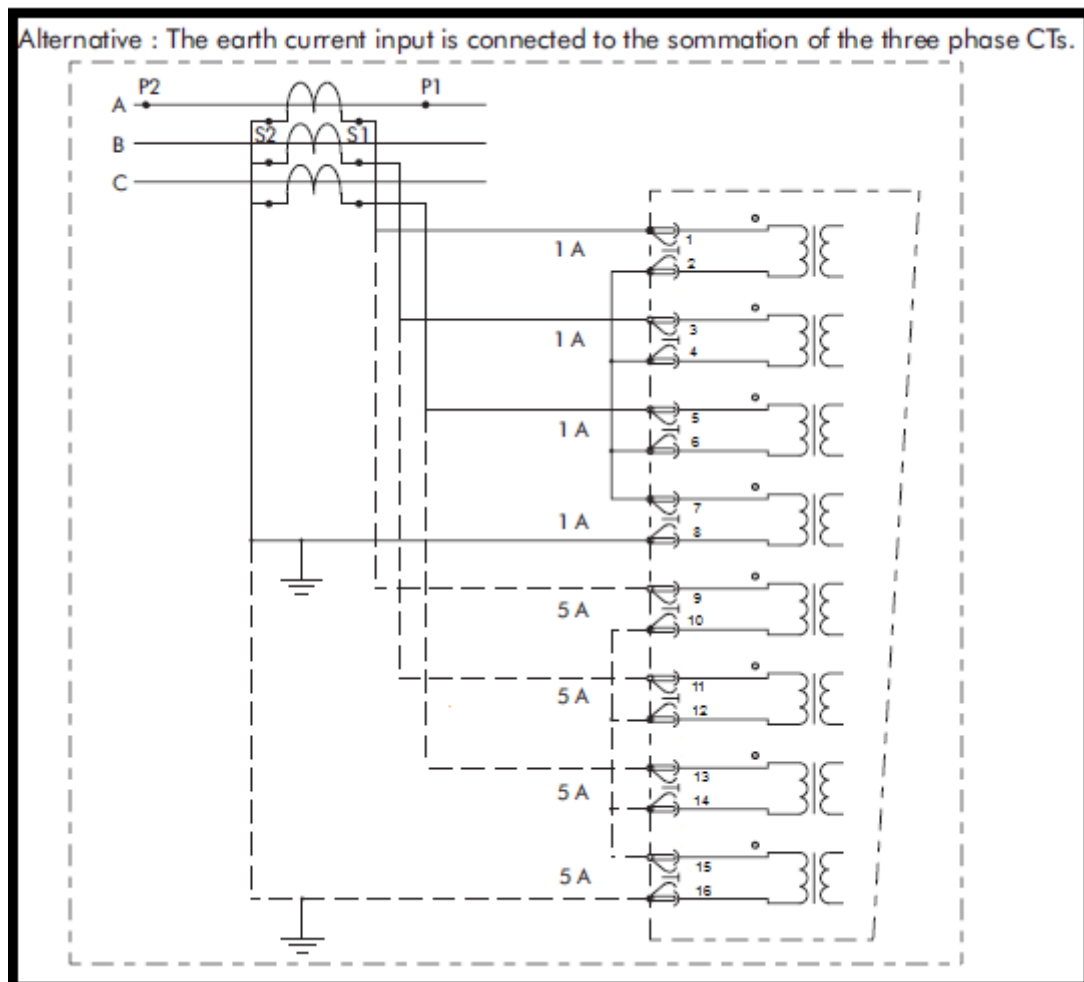

Wiring of CTs if the earth current is given from summation of 3 phase CTs instead of a core balanced CT.

T – 8.3 Phase current is given from 2 CTs & earth current from core balanced CT

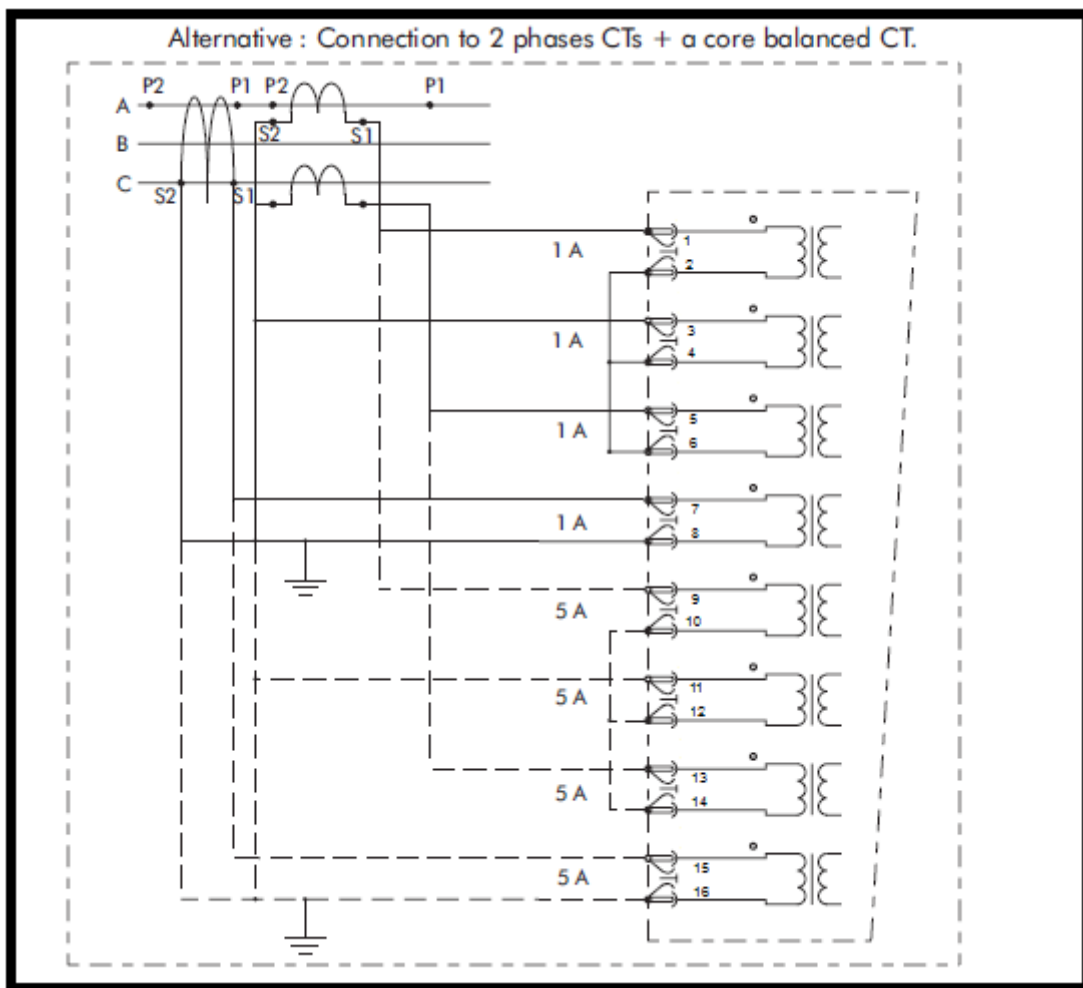

Wiring diagram if phase B input is connected to summation of -A & -C

T – 9: Wiring diagrams for MAPro102/103

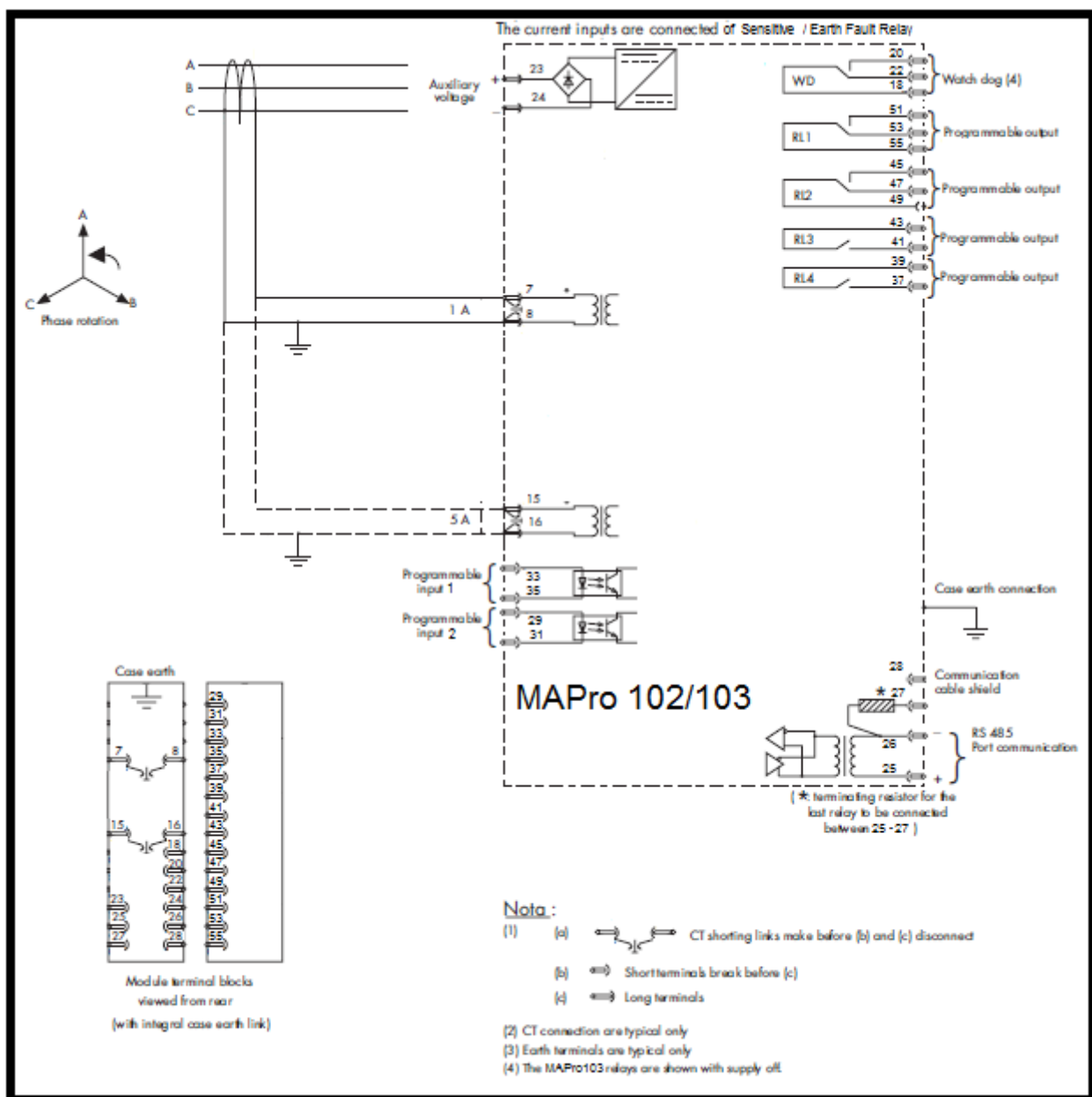

MAPro102/103, Earth fault / Sensitive earth fault Relay

T – 10: Wiring diagrams for MAPro101

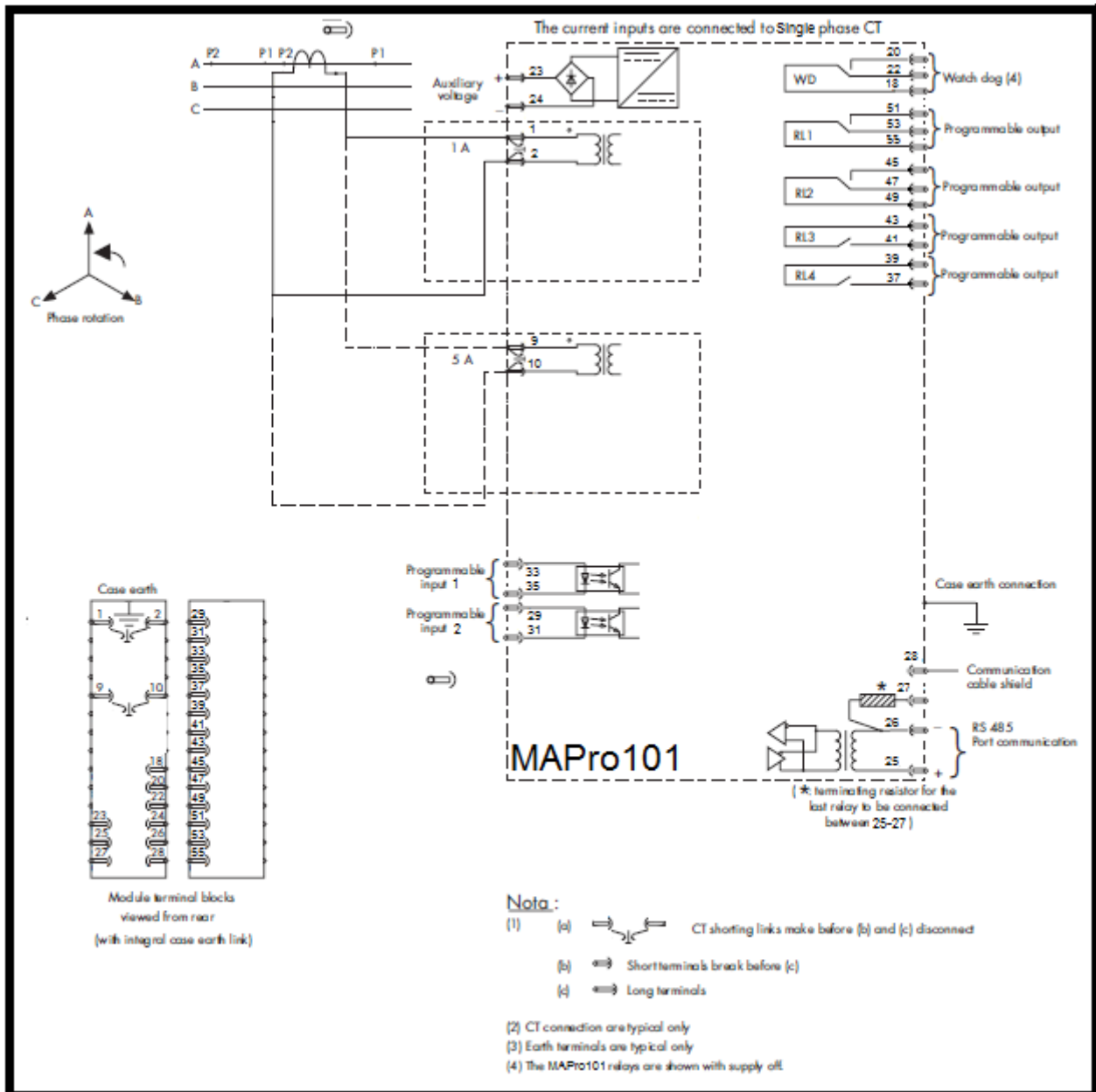

MAPro101, Single Phase over current Relay

T – 11: Wiring diagrams for MPro107

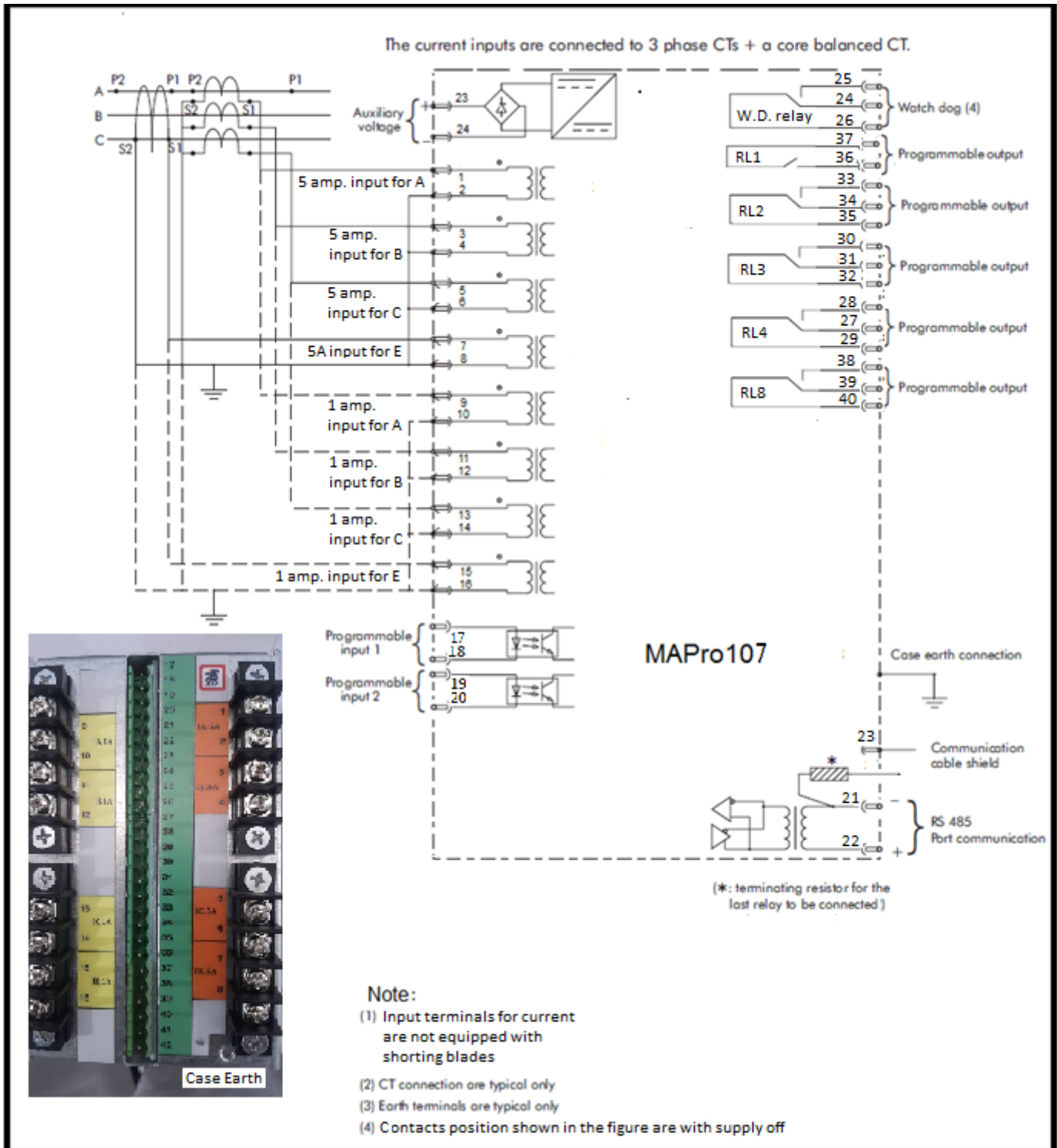

T-12: Cutout dimensions for MPro10 relays

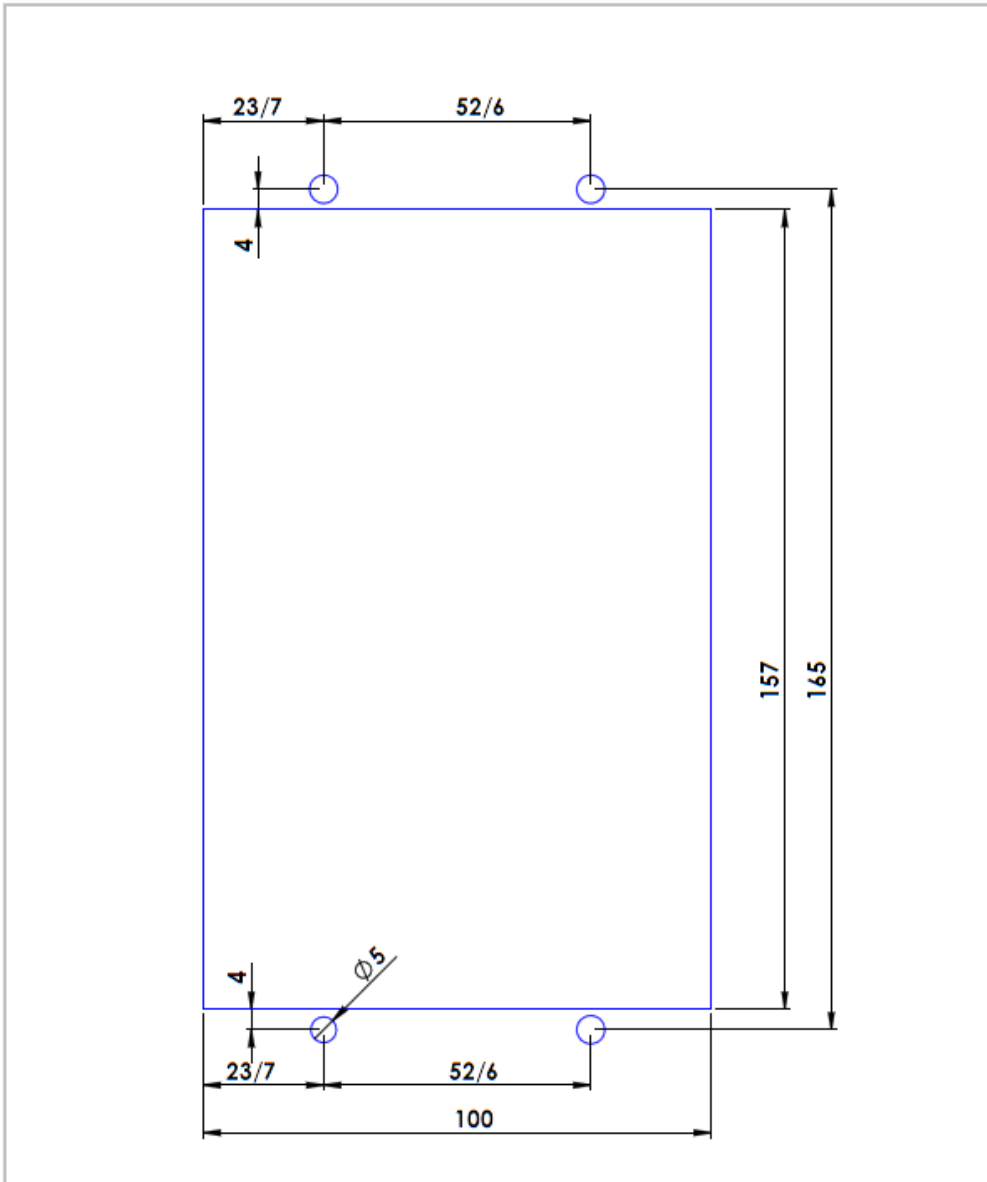

FINISH:				Fars Mehvar Azema	
NAME	SIGNATURE	DATE		TITLE:	
				MPro10 / MPro30 Panel cutout	
DRAWN				DWG NO.	A4
CHEK'D					
APP'VD					
MFG					
Q.A					
MATERIAL:			SCALE: 1:1		
WEIGHT:			SHEET 1 OF 1		

T – 13: Technical specifications according to standard:

T – 13.1 Mechanical specifications

Design

Modular FMA Full draw-out Case – 4U (out with automatic CT shorting in the case of the relay)

Mounting

Rack or flush mounting.

Connections

* Rear (double fasten + M4 screw per connection)*

Enclosure Protection

Front Panel: IEC 60529: 2001:

* IP 52 – Protection (front panel) against dust and dripping water

* IP 10 – Product safety protection for the rear due to live connections on the terminal block

Dimensions

Height: 4U (177mm)

Depth: 250mm

Width: 100mm

Weight

Approx.: 3.0 Kg

T – 13.2 Environmental conditions

Ambient Temperature Range

Per IEC 60255-6: 1988

Operating temperature range:

Continuous Withstand: –25 to +55°C (or –13°F to +131°F)

Storage Temperature Range: –25 to +70°C (or –28°F to +158°F)

Tested as per IEC 60068-2-1:2007:

–25°C storage (96 hours) –40°C operation (96 hours)

IEC 60068-2-2-2007: +85°C storage (96 hours)

+85°C operation (96 hours)

Note 1: The upper limit is permissible for a single 6- hour duration within any 24 hour period.

Ambient Humidity Range

Humidity:

* Per IEC 60068-2-78: 2001

* Per IEC 60068-2-30: 2005:

Solar radiation

Avoid exposure of the front panel to direct solar radiation.

T – 13.3 Mechanical environment**Vibration Test**

IEC 60255-21-1:1988

Vibration response Class 2 – 1g

Vibration endurance Class 2 – 2g

Shock and Bump Test

IEC 60255-21-2:1988

Shock response Class 2 – 10g

Shock withstand Class 1 – 15g

Bump Class 1 – 10g

Seismic Test

IEC 60255-21-3:1993: Class 2.

T – 13.4 Product safety

Compliance is demonstrated by reference to generic safety standards: IEC 60255-27:2005 EN 60255-5:2001

T – 13.5 Type tests**Insulation**

Rated insulation: 300

PER IEC 60255-5: 2000, Insulation resistance > 100MΩ at 500Vdc

High Voltage (Dielectric) Withstand

Per IEC 60255-5: 2000, 2 kV rms AC, 1 minute:

Between all case terminals connected together, and the case earth, and between all terminals of independent circuits (RS232 ports excepted).

2.0kVrms for one minute between all terminals and case earth

2.0kVrms for one minute between all terminals of independent circuits, including contact circuits

1.5kVrms for one minute across dedicated normally open contacts of output relays.

1.5kVrms AC for 1 minute, across open contacts and across open contacts of changeover output relays.

Impulse Voltage Withstand Test

Per IEC 60255-5: 2000

The product will withstand without damage impulses of 1.2 / 50 μ s, peak value: 5 kV, 0.5J across:

- * Each independent circuit and the case with the terminals of each independent circuit connected together.
- * Independent circuits with the terminals of each independent circuit connected together.
- * Terminals of the same circuit except normally open metallic contacts.

ELECTROMAGNETIC COMPATIBILITY (EMC)**DC Supply Interruption**

Per IEC60255-11:1979:

The product will withstand a 20ms interruption in the auxiliary voltage in its quiescent condition

AC Ripple on DC Supply

Per IEC60255-11:1979:

The product will operate with 12% AC ripple on the DC auxiliary supply without any additional measurement errors

Disturbances on AC Supply

Per IEC61000-4-11:1994:

The products satisfies the requirements of EN61000 - 4 - 11 for voltage dips and short interruptions.

1 MHz Burst High Frequency Disturbance Test

Per IEC 60255-22-1: 2008, Class III,

Common-mode test voltage: 2.5 kV,

Differential test voltage: 1.0 kV,

Test duration: 2 s, Source impedance: 200 Ω **Electrical Fast Transient or Burst Requirements**

Per IEC 60255-22-4: 2002

The product complies with all classes up to and including Class A 4kV without any mal-operations or additional measurement errors.

Fast transient disturbances on terminal block, communications (common mode only)	2kV, 5ns rise time, 50ns decay time, 5kHz repetition time, 15ms burst, repeated every 300ms for 1min in each polarity, with a 50 Ω source impedance.
Fast transient disturbances on power supply, I/O signal, data and control lines (common mode only)	4kV, 5ns rise time, 50ns decay time, 2.5kHz repetition time, 15ms burst, repeated every 300ms for 1min in each polarity, with a 50 Ω source impedance.

Per IEC 61000-4-4: 2004.

The product complies with all classes up to and including Level 4, 4kV without any mal-operations or additional measurement errors:

Fast transient disturbances on power supply (common mode only)	2kV, 5ns rise time, 50ns decay time, 5kHz repetition time, 15ms burst, repeated every 300ms for 1min in each polarity, with a 50Ω source impedance.
Fast transient disturbances on I/O signal, data and control lines (common mode only)	2kV, 5ns rise time, 50ns decay time, 5kHz repetition time, 15ms burst, repeated every 300ms for 1min in each polarity, with a 50Ω source impedance.

Immunity to Electrostatic Discharge

Per IEC 60255-22-2: 1997 & IEC61000-4-2:2001

The product will withstand application of all discharge levels up to the following without Mal - operation:

15 kV discharge in air to user interface, display, and exposed metalwork.

8 kV discharge in air to all communication ports.

8 kV point contact discharge to any part of the front of the product.

Conducted Emissions

Per EN 55022: 1998:

0.15 – 0.5MHz, 79dBμV (quasi peak) 66dBμV (average)

0.5 – 30MHz, 73 dBμV (quasi peak) 60dBμV (average).

Radiated Emissions

Per EN 55022: 1998:

30 - 230MHz, 40dBμV/m at 10m measurement distance

230 – 1GHz, 47dBμV/m at 10m measurement distance.

Immunity to Radiated Electromagnetic Energy

Per IEC 60255-22-3: 2000, Class III & IEC61000-4-3:2002

Test field strength, frequency band 80 to 1000 MHz:

10 V/m, test using AM: 1 kHz / 80%, at 80 to 1GHz,

30 V/m, test using AM: 1 kHz / 80%, at 80 to 900MHz and 1.4GHz to 2.0GHz

Conducted Immunity

Per IEC 60255-22-6: 2001

10 V/m, test using AM: 1 kHz / 80%, at 0.15 to 80MHz

Surge Immunity

Per IEC 60255-22-5: 2002

Class IV: 4kV common mode 12Ω source impedance, 2kV differential mode 2Ω source impedance – power supply

Class IV: 4kV common mode 42Ω source impedance, 2kV differential mode 42Ω source impedance – Opto inputs, relays, CT, VT

Class IV - 4kV common mode 2Ω source impedance applied to cable screen – terminal block communications

Power Frequency Magnetic Field Immunity

Per IEC 61000-4-8:2001, class V: 100A/m quiescent condition, 1000A/m short duration (1-3s)

Pulse Magnetic Field Immunity

Per IEC 61000-4-9:2001, class V: 1000A/m pulse (5 positive, 5 negative)

Damped Oscillatory Magnetic Field

Per IEC 61000-4-10:2001, class V: 100A/m @ 100kHz / 1MHz 2 second burst duration

Oscillatory Waves Immunity

Per IEC 61000-4-12:2001:

2.5kV peak between independent circuits and case earth

1.0kV peak across terminals of the same circuit

EMC compliance

EN50081-2: 1994

EN60952-2: 1995

Product Specific Standards were used to establish conformity: EN50263: 2000

U: User guide

U – 1: Comparison of different models

U – 1.1: MAPro 105

This type of over current relay has the following protection functions on 3 power lines & earth:

- **Phase over current**, in 3 **independent** configurable levels I>, I>>, I>>>. All of these levels can be configured in their own menus. I> and I>> levels can protect in DMT (definite time) and eight different IEC & IEEE IDMT curves. Also definite reset time can be defined. Each of 8 LEDs can be selected as pick up or trip or both indications. There are 8 output relays that can be configured in any way that user wants for each level (each of them and any combination of them can be selected). I>>> is specified for fast and fixed time operation, so it dose not contain IDMT and pick up LED and reset time.

Pick up current level is the same as threshold setting and drop out current level is 95% of threshold setting.

For I> & I>>, if IDMT is selected, Pick up level is at threshold setting but time is measured from 1.1 of threshold setting according to selected curve.

- **Earth fault (earth over current)**, in 3 **independent** configurable levels IE>, IE>>, IE>>>. All of these levels can be configured in their own menus. IE> and IE>> levels can protect in DMT (definite time) and eight different IEC & IEEE IDMT curves. Also definite reset time can be defined. Each of 8 LEDs can be selected as pick up or trip or both indications. There are 8 output relays that can be configured in any way that user wants for each level (each of them and any combination of them can be selected). IE>>> is specified for fast and fixed time operation. So it dose not contain IDMT and pick up LED and reset time.

Pick up current level is the same as threshold setting and drop out current level is 95% of threshold setting.

For IE> & IE>>, if IDMT is selected, Pick up level is at threshold setting but time is measured from 1.1 of threshold setting according to selected curve.

- **Negative sequence over current**, one configurable level I2>. I2> can protect in DMT (definite time) and eight different IEC & IEEE IDMT curves. Also definite reset time can be defined. Each of 8 LEDs can be selected as pick up or trip or both indications. There are 8 output relays that can be configured in any way that user wants for each level (each of them and any combination of them can be selected).

Pick up current level is the same as threshold setting and drop out current level is 95% of threshold setting.

If IDMT is selected, Pick up level is at threshold setting but time is measured from 1.1 of threshold setting according to selected curve.

- **Under current**, in one **independent** configurable level I<. This level can be configured in its own menu. I<, operates in DMT (definite time) mode. LEDs 5 to 8 can be selected operate indication. There are 8 output relays that can be configured in any way that user wants for operation of this function. e.

Under current operation can be blocked in two ways:

- 1- By defining a threshold current from **configuration menu** on relay or **setting menu** on PC software. In this case if all 3 phase currents are below this defined threshold, under current operation, if is active, will be blocked.
- 2- By selecting inputs 1 or 2 from **configuration menu** on relay or **setting menu** on PC software. In this case, if selected input is high, under current operation, if is active, will be blocked. If both options are active, their effect is with **OR logic**. Pick up (descent) current level is the same as threshold setting and drop out current level is 105% of threshold setting.

U – 1.2: MAPro 104

The functions of MAPro 104 is completely the same as MAPro 105 except that it has 2 digital inputs instead of 5 inputs, and it has 4 configurable output relays instead of 8 relays. **So in settings of this type, be careful not to select relays 5 to 8 for any of protection functions.** Also the functions TCS and Autoreclose are not existed in MAPro 104.

U – 1.4: MAPro 101

This type has only one analog input for phase current, so it is applicable for one phase over current protection. The functions are **phase over current, I>, I>>, I>>>**. The setting related menus are the same as similar functions in MAPro 104 & 105. It has 2 digital inputs, and 4 configurable output relays. **So in settings of this type, be careful not to select relays 5 to 8 for any of protection functions.**

U – 1.5: MAPro 102

This type has only one analog input for earth current, so it is applicable for earth over current protection. The functions are **earth over current, IE>, IE>>, IE>>>**. The setting related menus are the same as similar functions in MAPro 104 & 105. It has 2 digital inputs, and 4 configurable output relays. **So in settings of this type, be careful not to select relays 5 to 8 for any of protection functions.**

U – 1.6: MAPro 103

This type has only one analog input for earth current, so it is applicable for sensitive earth over current protection. The functions are **sensitive earth over current, IE>, IE>>, IE>>>**. The setting related menus are the same as similar functions in MAPro 104 & 105 but the ranges are different, they are as given in technical specifications. It has 2 digital inputs, and 4 configurable output relays. **So in settings of this type, be careful not to select relays 5 to 8 for any of protection functions.**

U – 2: User interfaces

U – 2.1: Relay

Display: 2x16 character LCD with backlight to access settings from relay or observing settings or measurements.

LED: one blinking green to show, - external & internal power supply safety
- CPU correct operation

Eight red LED, all of them not fixed and configurable for any function operation

Right & left keys: to move between different menus

Up & down keys: to increment or decrement parameters or view fault information or showing date & time

CLEAR key: to going to main menu from other menus or reset LED or relays which are operated and latched, if the operation condition is not still continued. To turn off the trip LED which is latched after each trip, keep CLEAR key pushed for 3 seconds. READ key: to access to faults information

USB connector, for PC or laptop connection

Label tape, positioned on top of front panel, contains the relay main specifications.

Back terminal block: the connection and wiring guide is given in [T – 7](#), [T – 8](#), [T – 9](#), [T – 10](#) sections.

U – 2.2: Relay settings & menus, using keypad & display

MAPro 10 Menu Contents

MAPro 10	R:
0°	
MAPro 10	S:
240°	
MAPro 10	T:
120°	
MAPro 10	
E:	

The following information are shown in the **main menu** for each analog input **one after another**:

- Phase angle related to R(input 1)in degrees
- Secondary current of external CT in Ampers as Is
- Primary current of external CT in Ampers as Ip

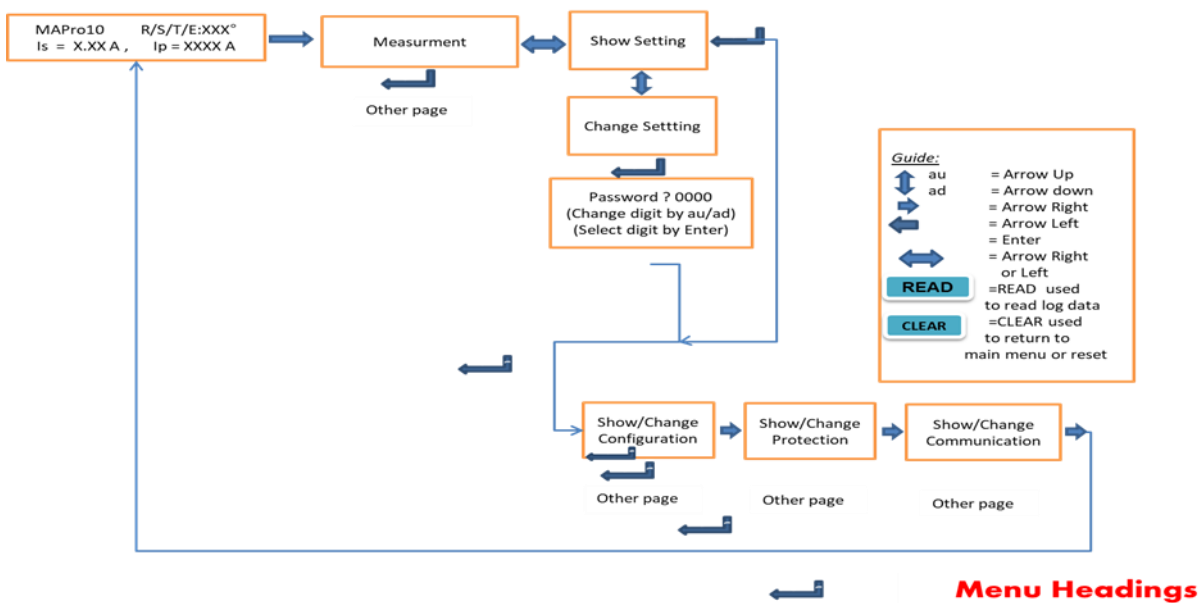

Note: When the relay is in normal condition, by pushing “Arrow up” key, time is shown on display.

When the relay is in normal condition, by pushing “READ” key, the last 5 faults is shown on display, in this case, by “Arrow UP or DOWN” the next or previous faults will be shown and by “Arrow Right” key, the detailed information of existed fault will be shown.

When the relay is in any submenu, by pushing “CLEAR” key, it returns to main menu.

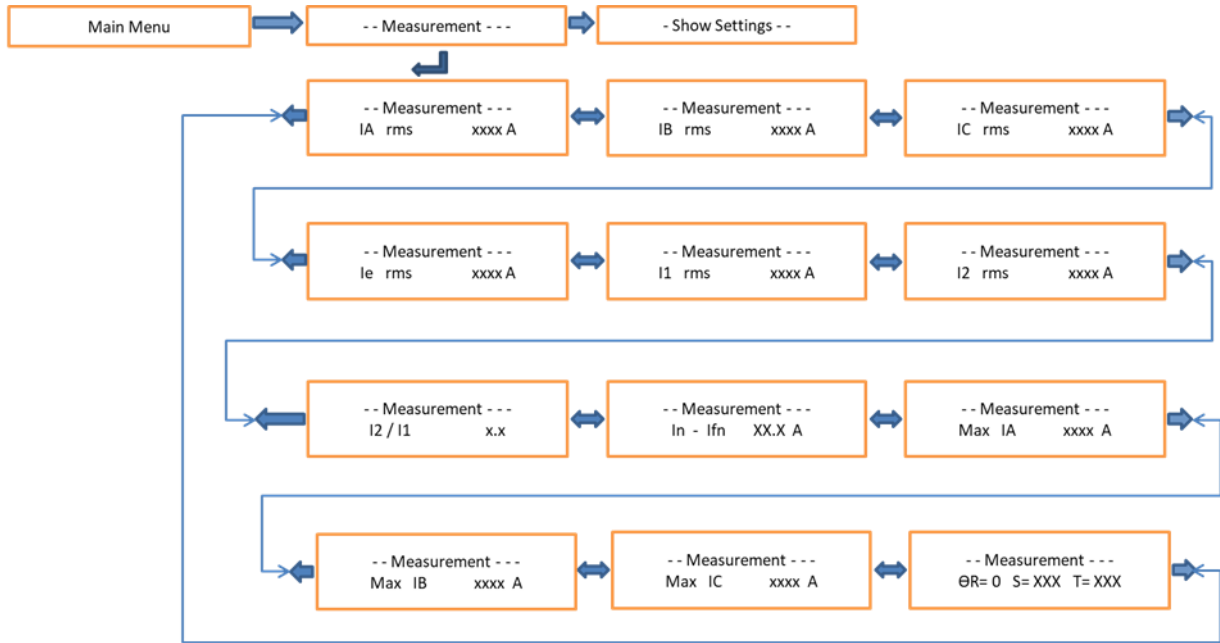

In each of Measurement submenus by pressing  it goes to "Show Settings" menu

Measurement Menu

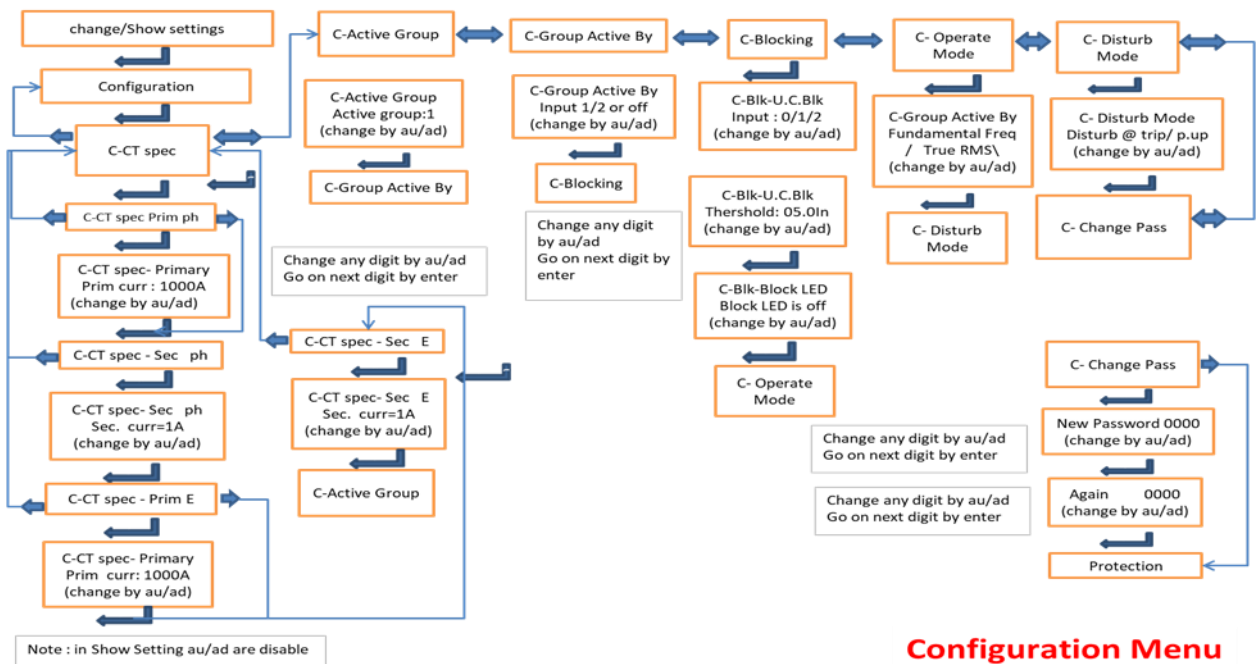

Configuration Menu

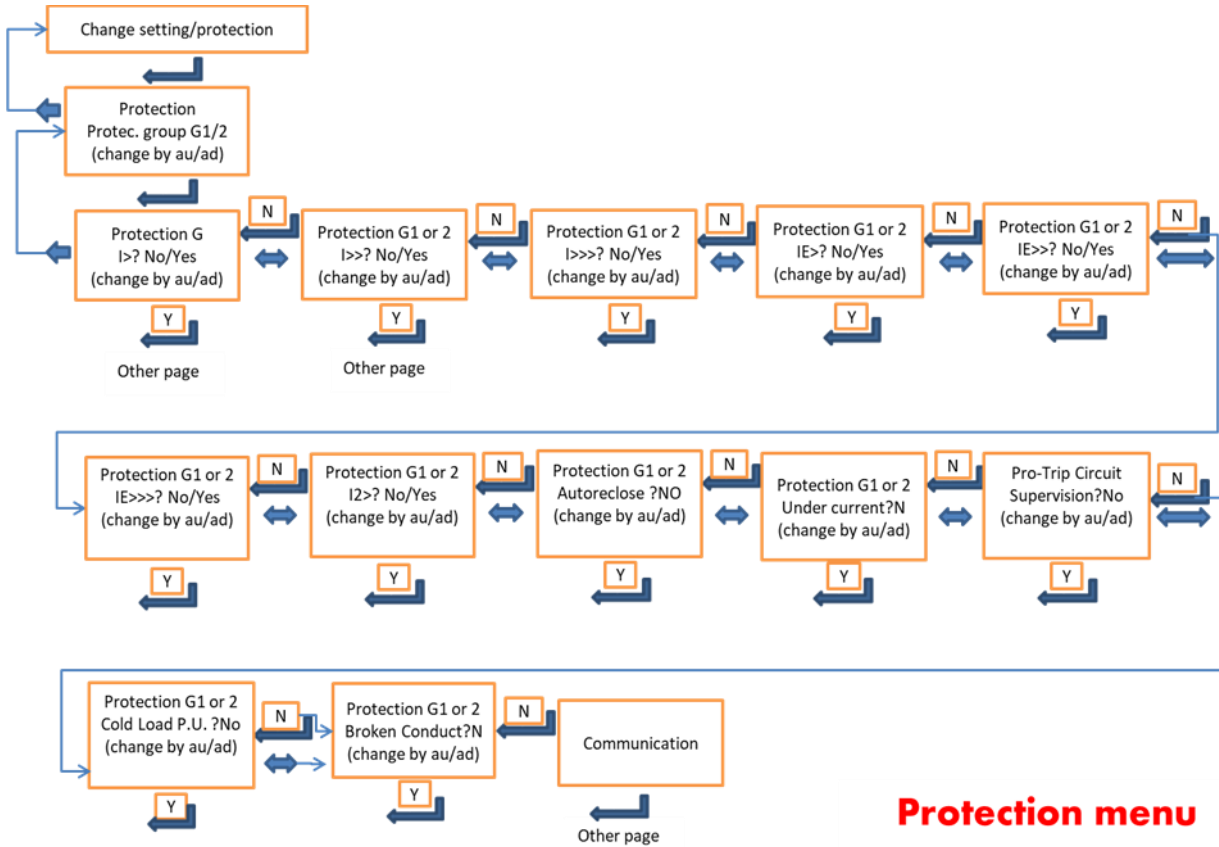

Protection menu

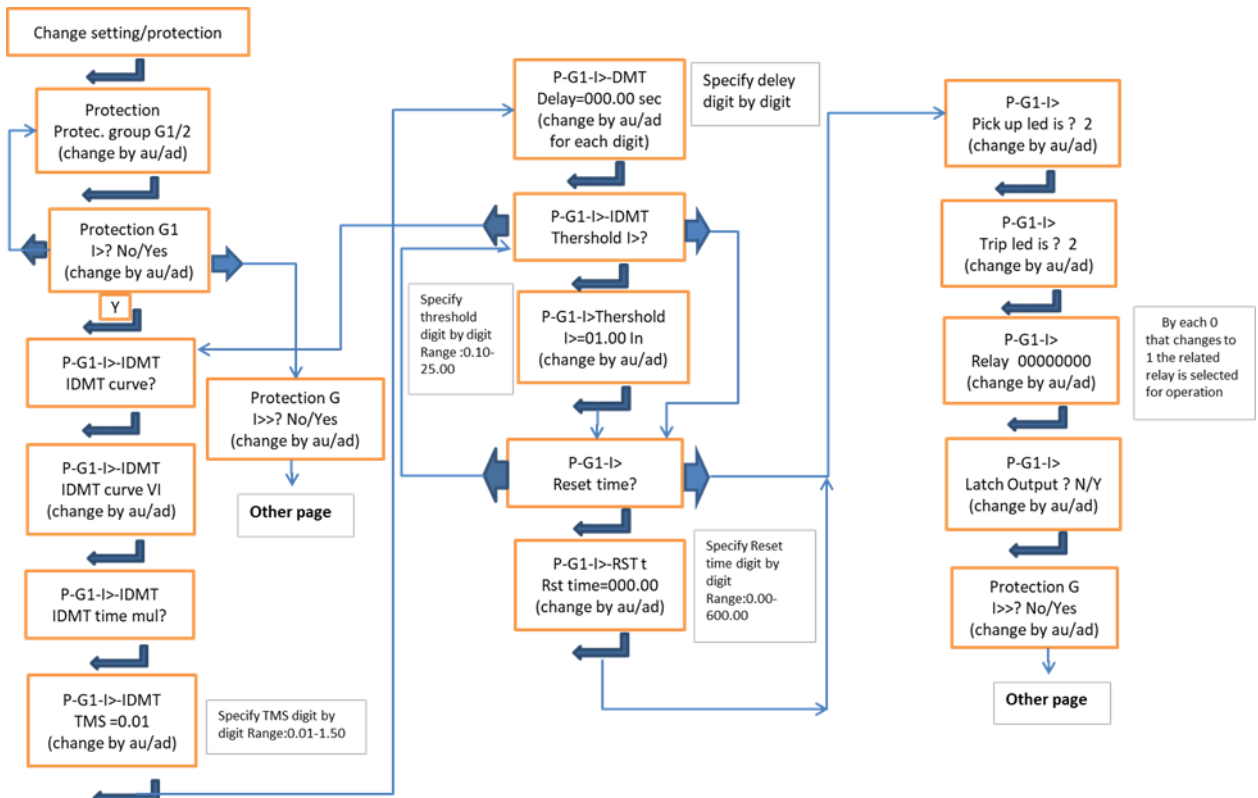

I> setting menu

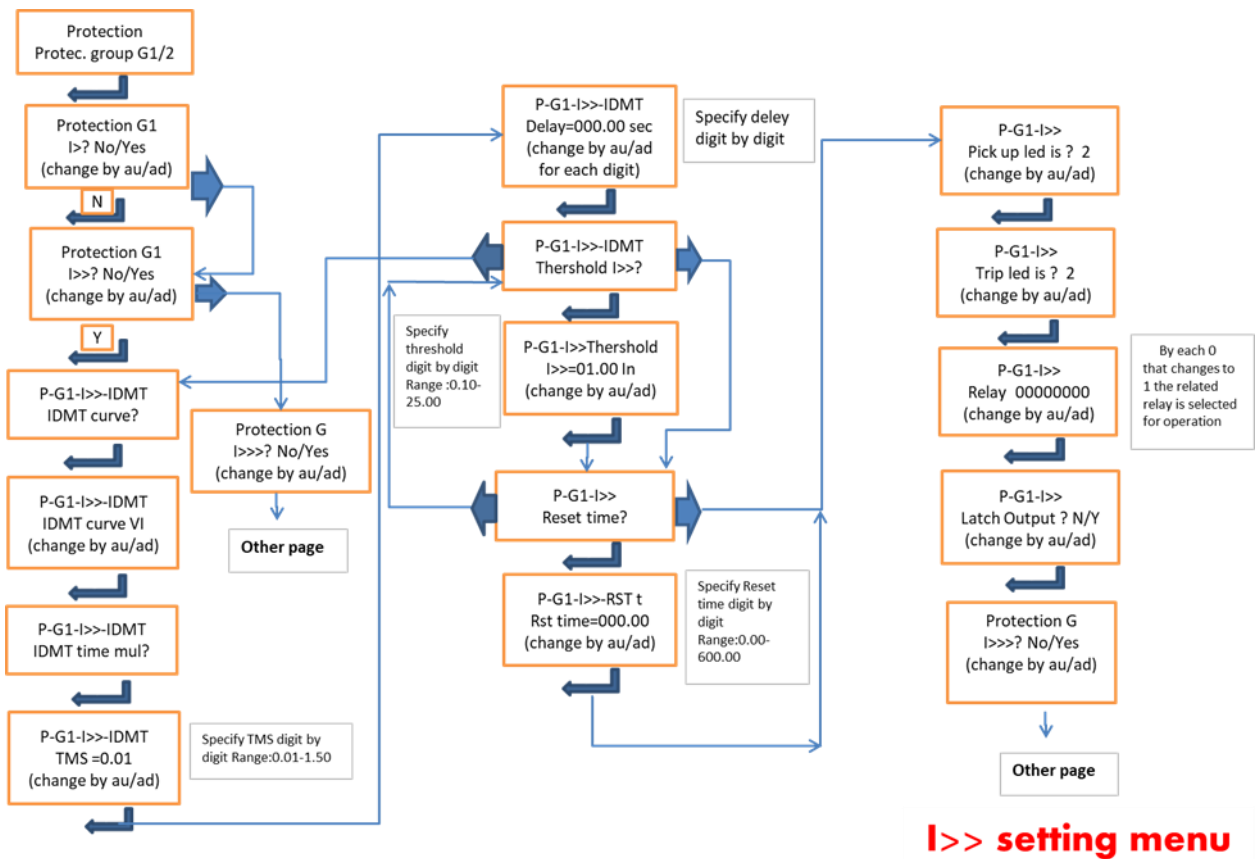

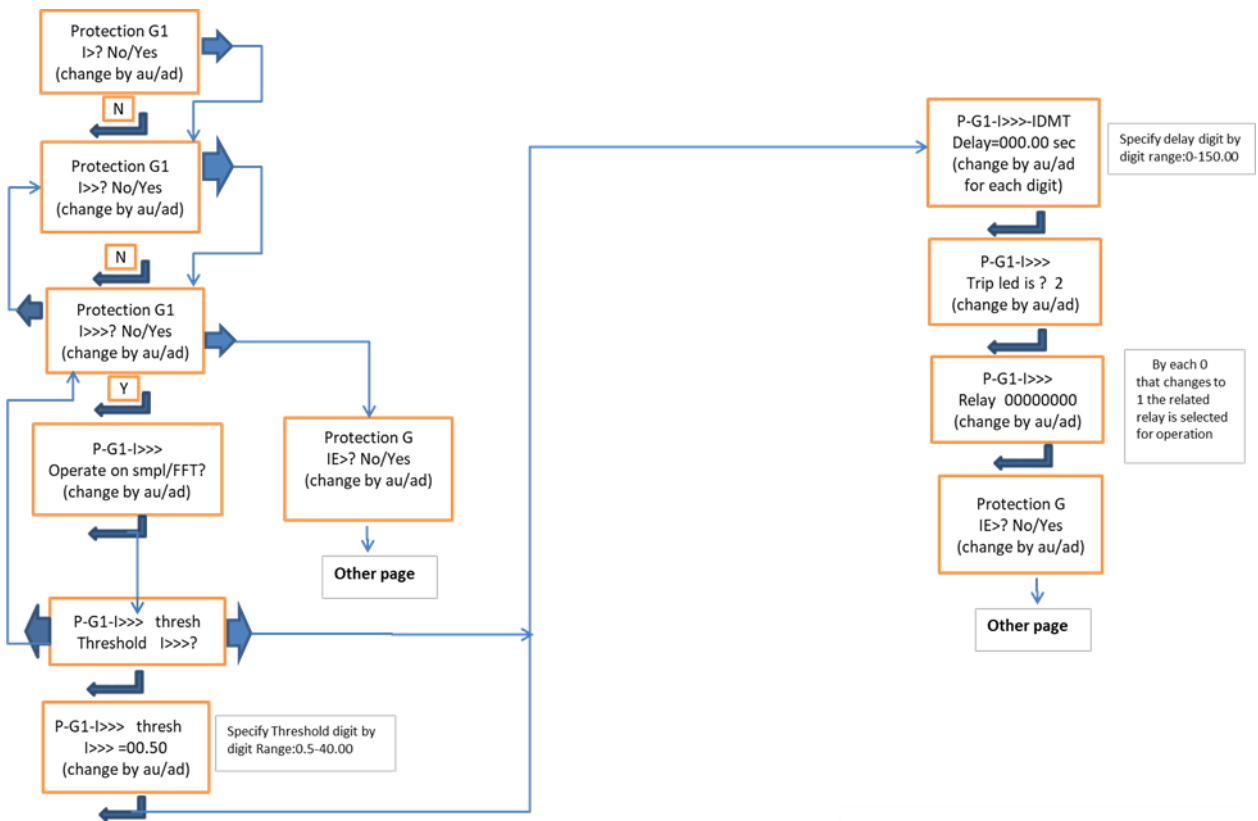

I>>> setting menu

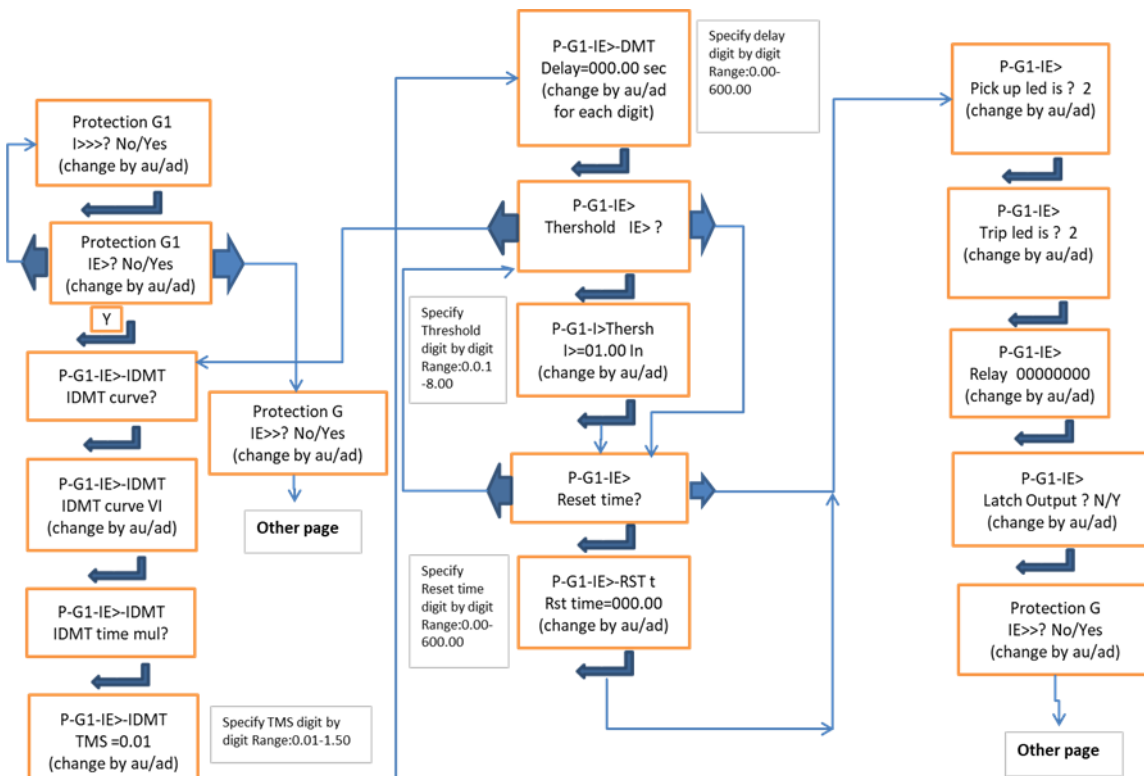

le> setting menu

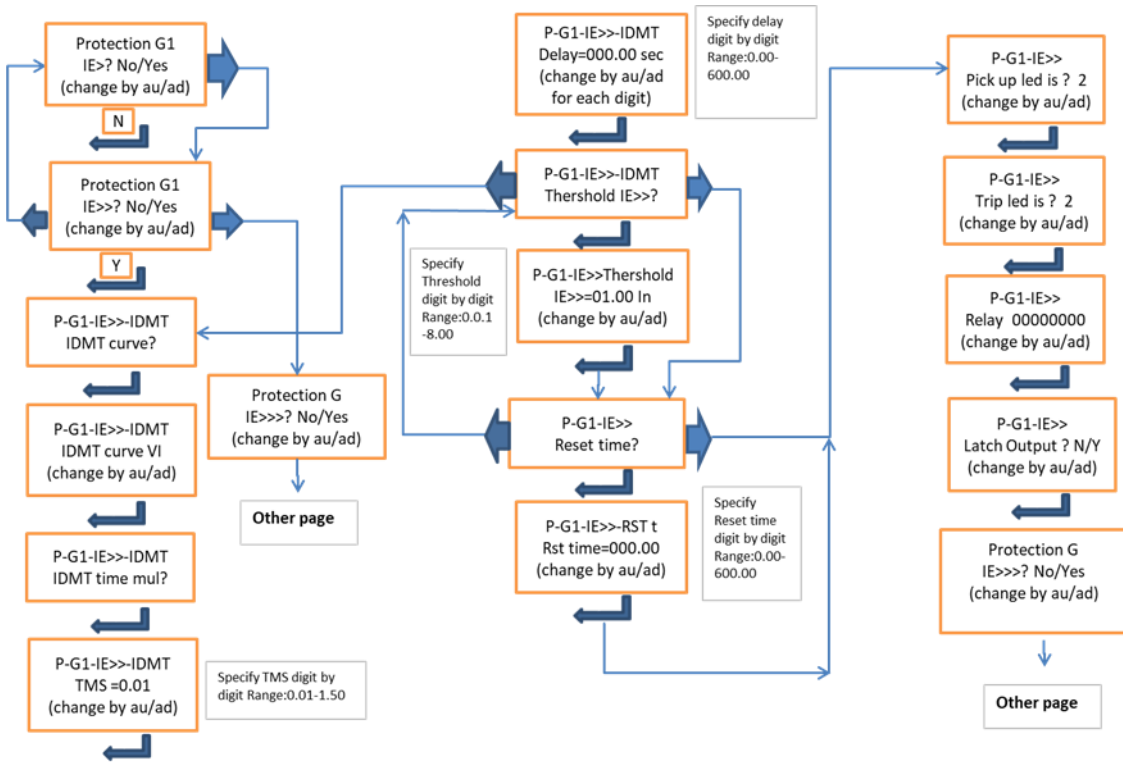

le>> setting menu

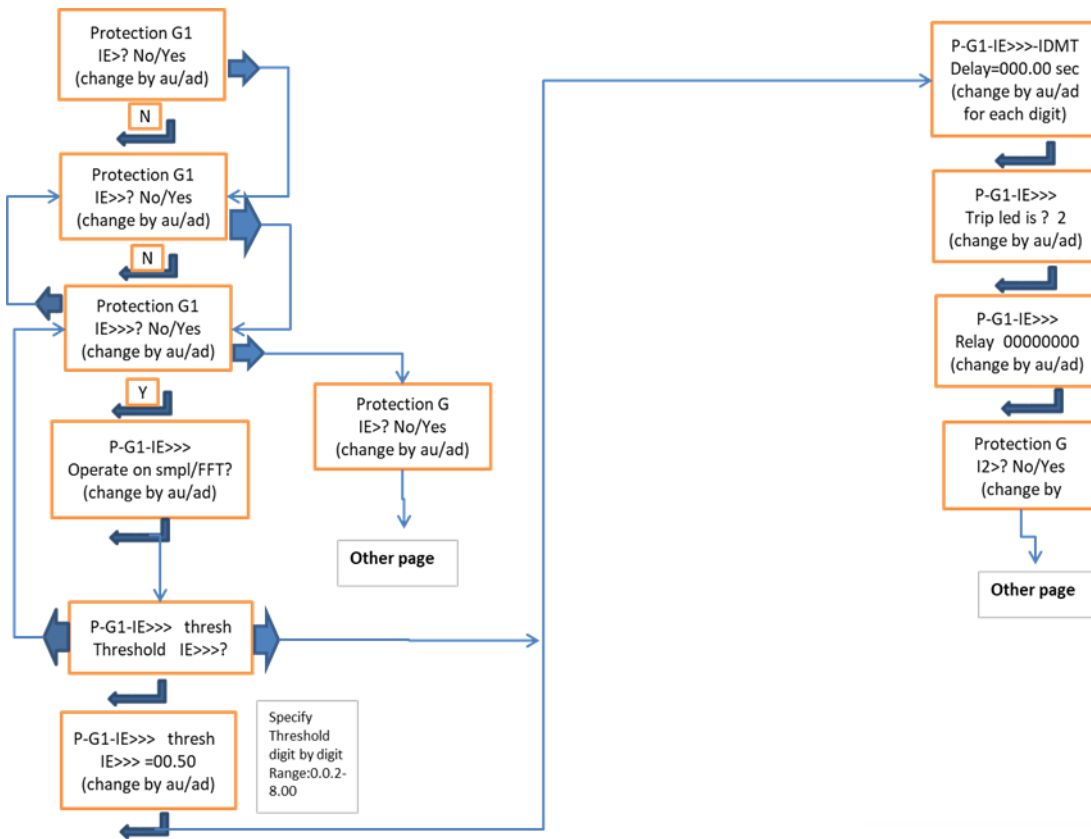

le>>> setting menu

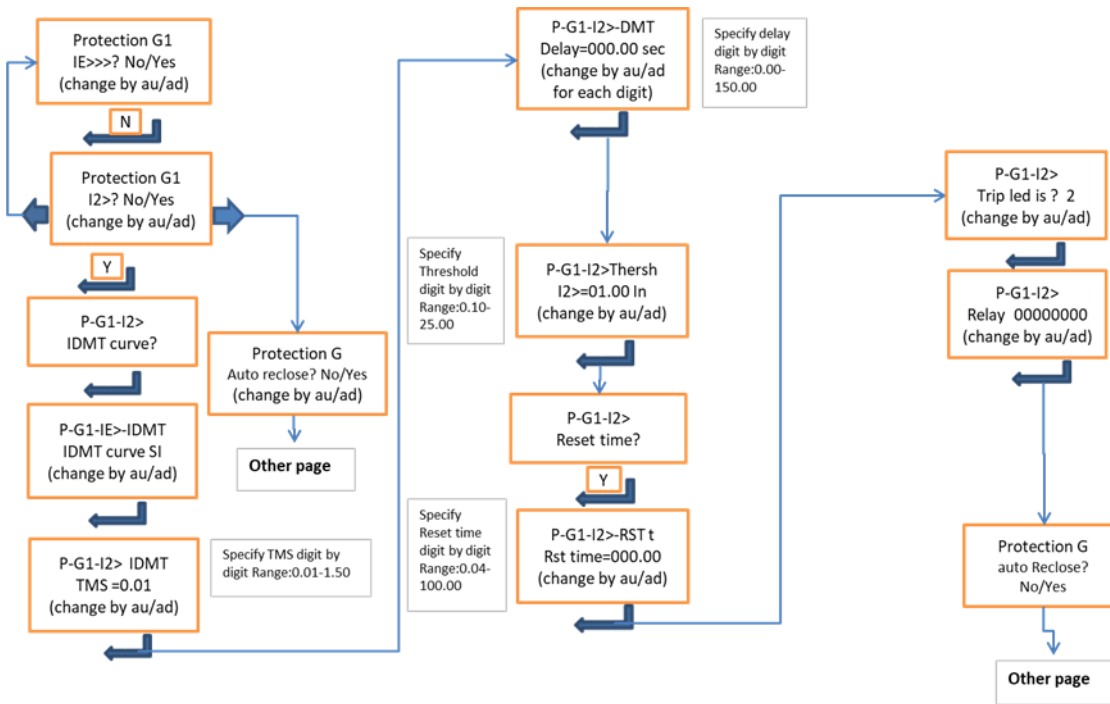

I2> setting menu

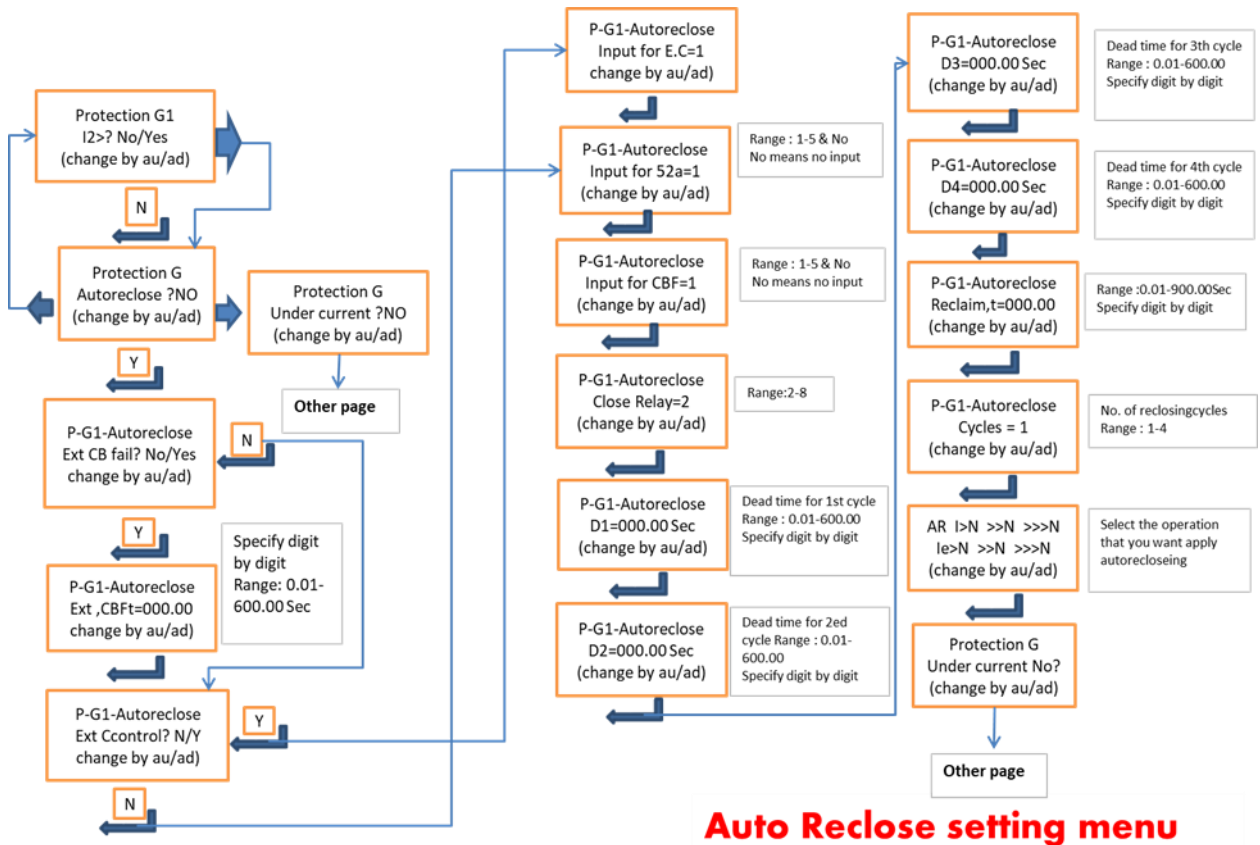

Auto Reclose setting menu

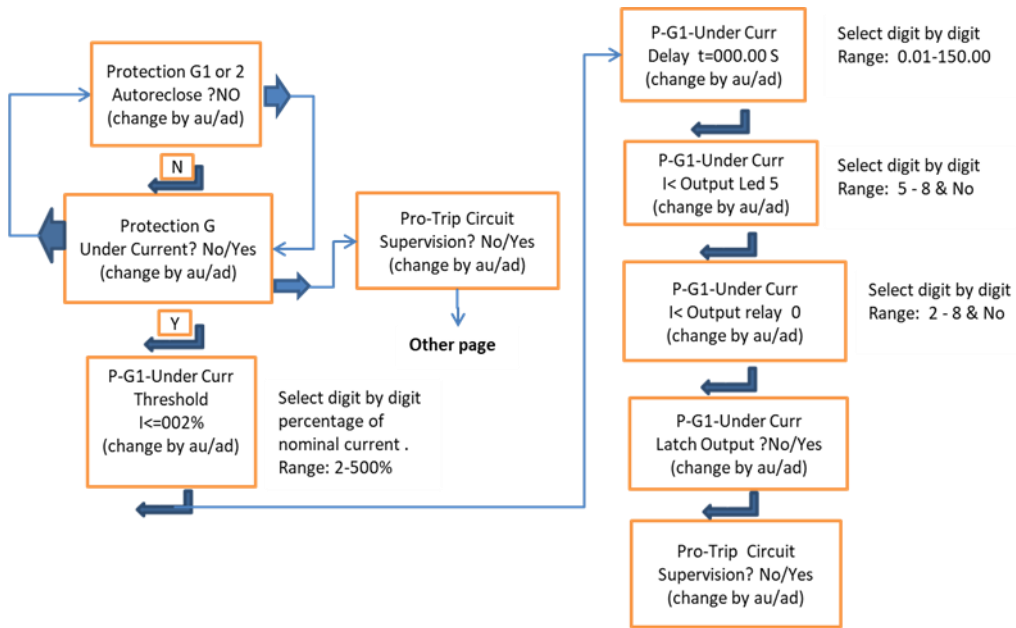

I< setting menu

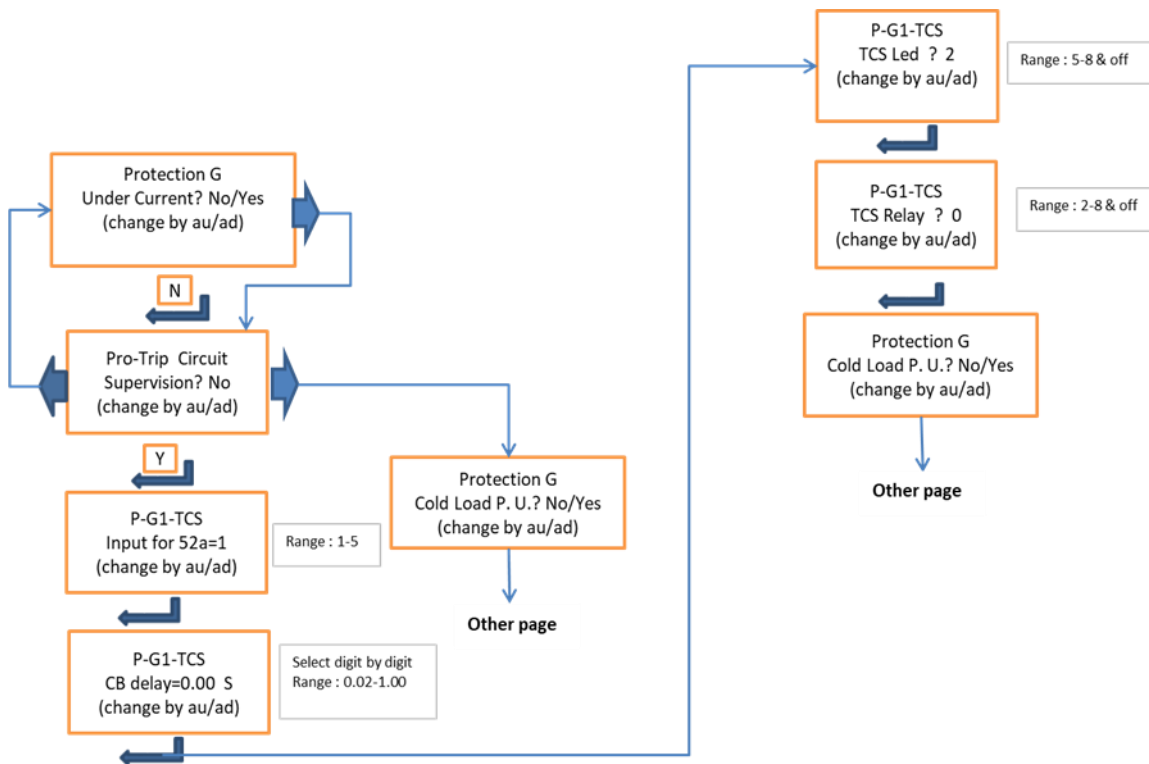

TCS setting menu

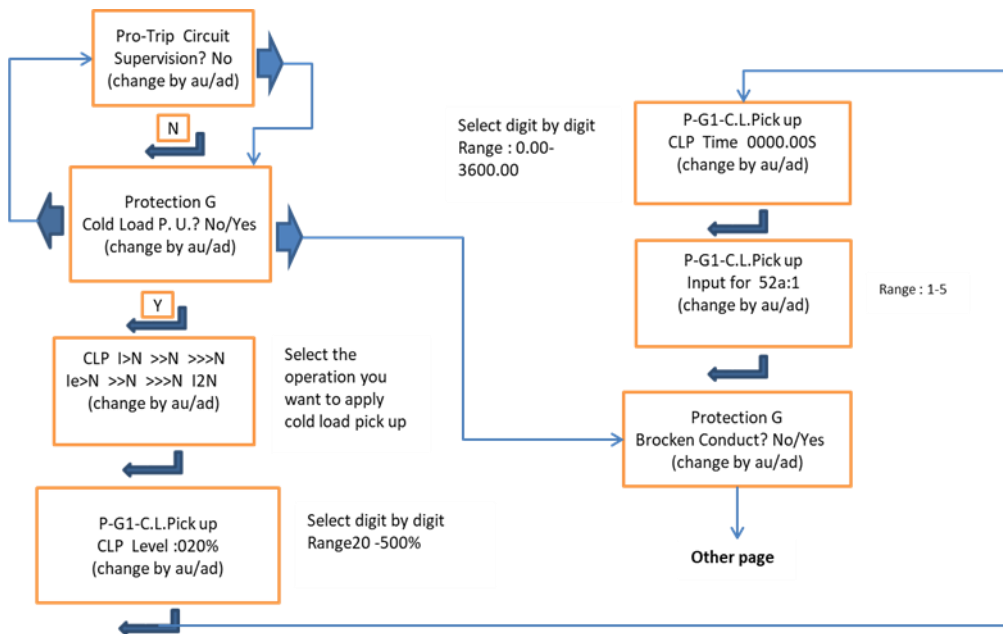

Cold Load Pickup setting menu

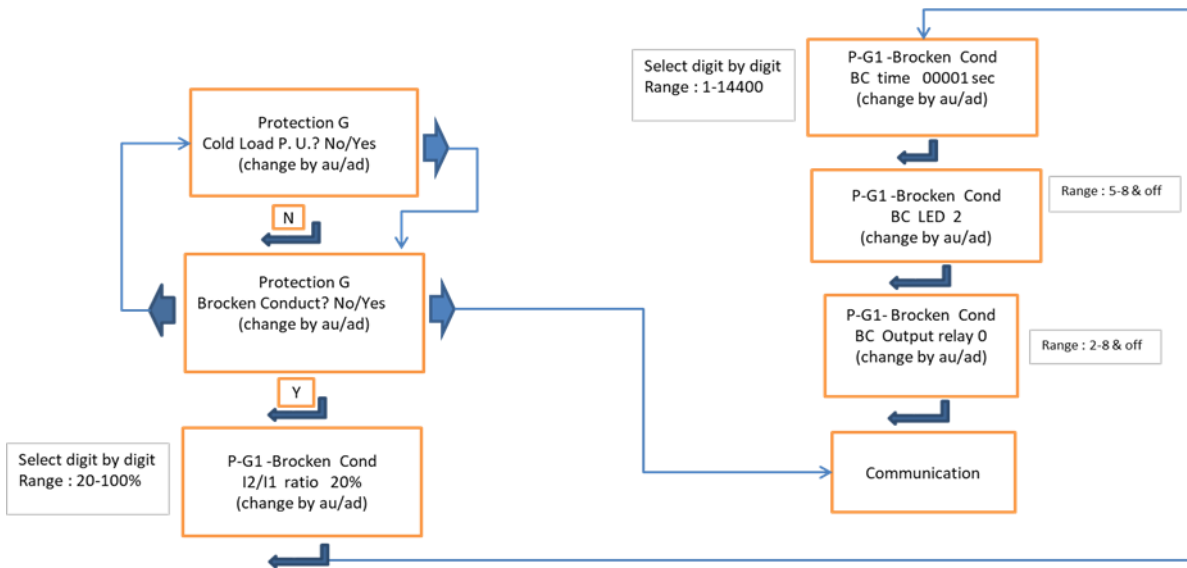

Broken Conductor setting menu

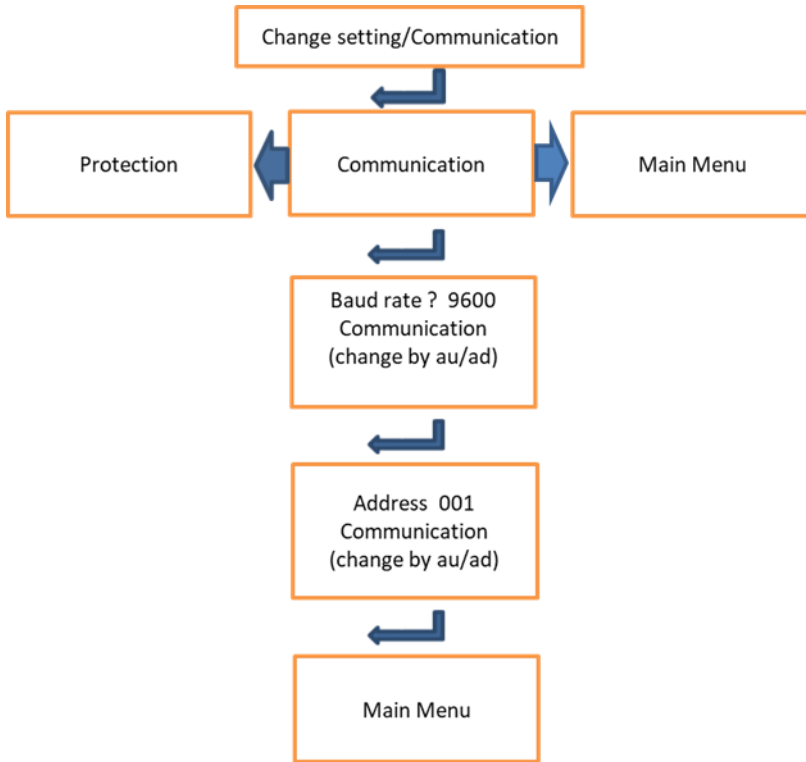

Communication Setting Menu

U – 2.3: Relay settings & menus, using PC software

MAPro System Setting with PC

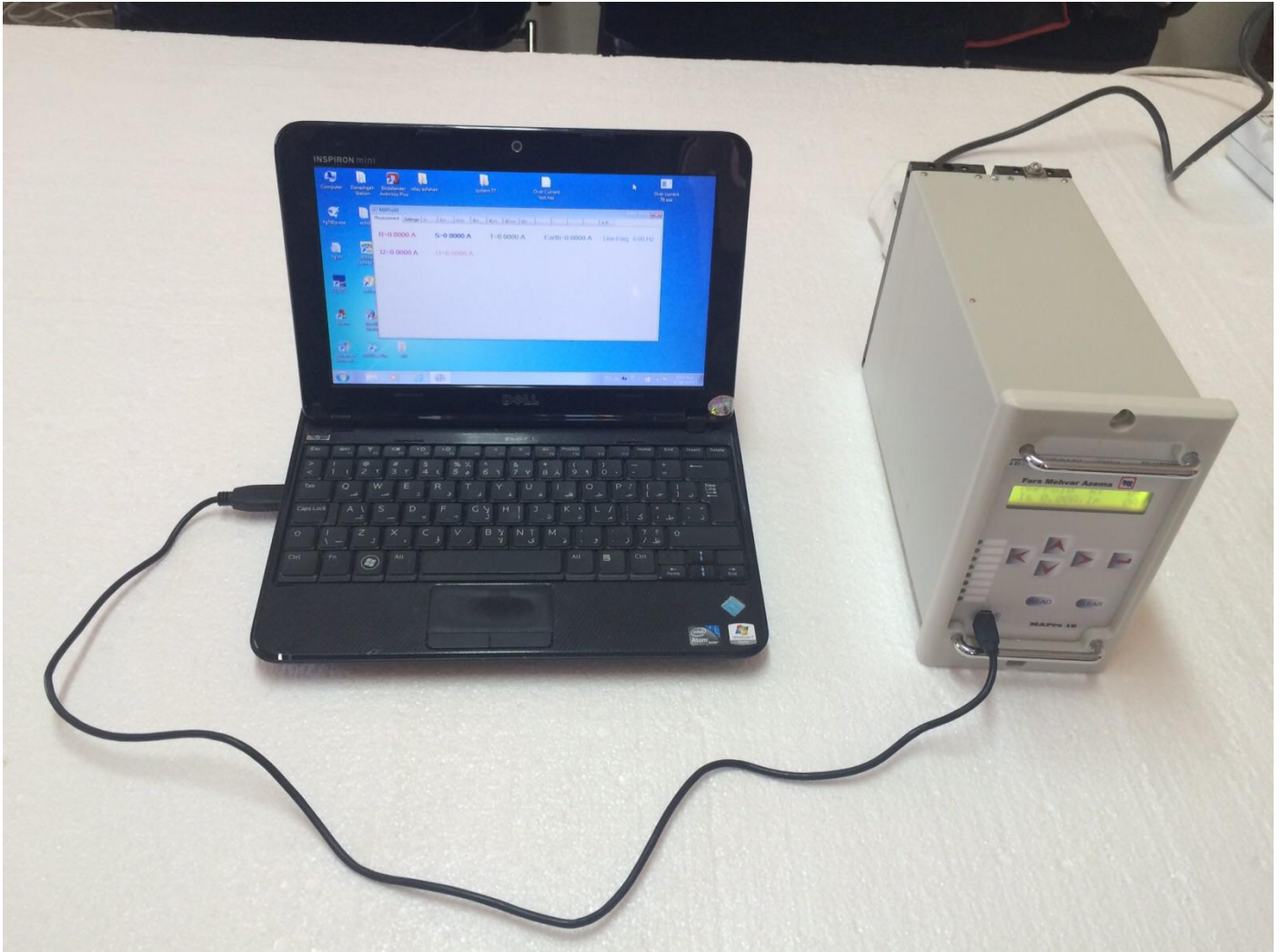

- Install driver (FTDI driver) on PC if there is not.
- Connect system with USB cable to PC.
- Run “MAPro Setting.exe” Program.



Then you have this menu. This shows the online measurements. This menu will be active only when the computer is connected to relay via USB port.

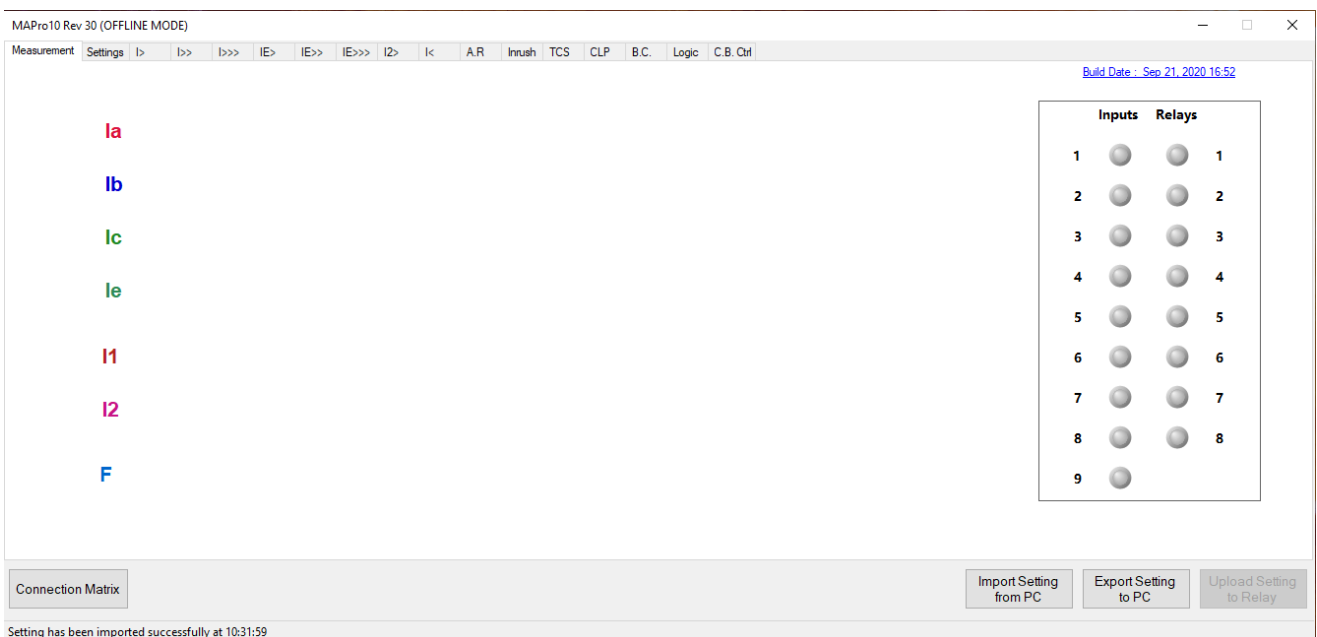

If no relay is connected to PC , after running the “MAPro Setting” program you will have this menu,

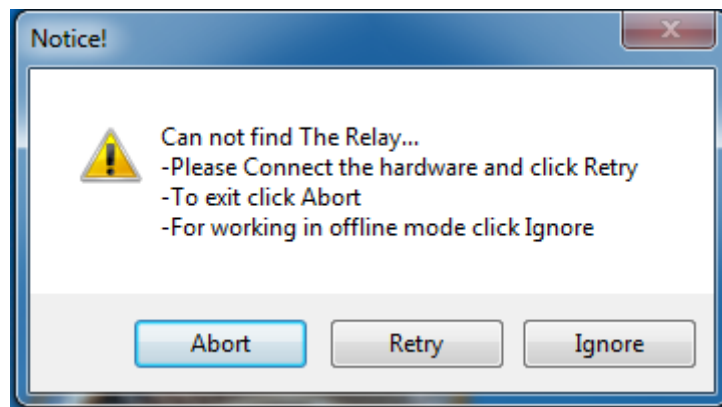

By selecting “Ignore”, you will have

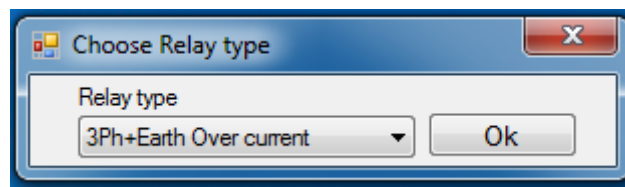

After selecting relay type (“3Ph+Earth Over current”, or “sensitive Earth Over current”, or “Over/Under Voltage”, or “Earth fault relay” or “Combo relay”) you will have its setting menu.

For example if select “3Phase +Earth Over current” you have the other setting menus in offline condition.

Configuration settings:

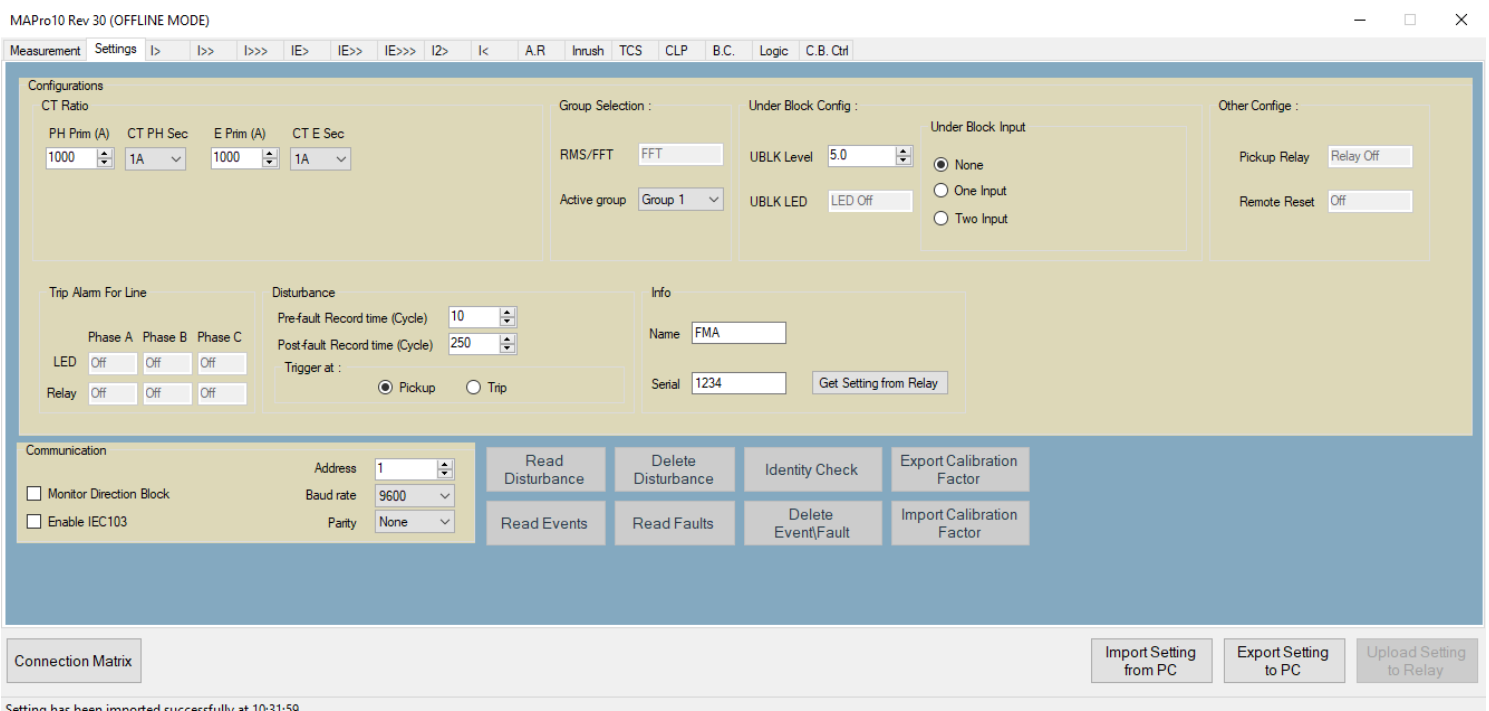

Configuration settings menu

To have access to set the application of inputs, outputs or LEDs, or have observation to them, there is a key at lower border of menu, named "Connection matrix".

The applications of this software key are:

- Activate any input/output/LED to any function
- Assign a name label to inputs/outputs/LEDs
- Observation of input/output/LEDs application in this relay according to setting
- Hotline monitoring the inputs/outputs/LEDs situation
-

Name	Relay 1	Relay 2	Relay 3	Relay 4	Relay 5	Relay 6	Relay 7	Relay 8
Over Current 1								
Over Current 2								
Over Current 3								
Neutral Over Current 1								
Neutral Over Current 2								
Neutral Over Current 3								
Negative Sequence								
Under Current								
Broken Conductor								
Trip Circuit Supervision								
Auto Reclose								
Relay for phase A								
Relay for phase B								
Relay for phase C								
Pickup Relay								
Circuit Breaker Open Relay								
Circuit Breaker Close Relay								
Input 1								
Input 2								
Input 3								

connection matrix for relays (outputs) settings

Active Group : Group 1 Group 2

Selected Feature : LEDs Relays Inputs

Buttons: Confirm, Rename Inputs

Name	Input 1	Input 2	Input 3	Input 4	Input 5
Input 52a					
External Control					
Circuit Breaker Ready					
Inhibit					
Auto Reclose Input					
▶ Remote Reset					
First Input for Opening					
First Input for Closing					
Second Input for Opening					
Second Input for Closing					
Input 1 for Under Block					
Input 2 for Under Block					

connection matrix for digital inputs settings

Active Group : Group 1 Group 2

Selected Feature : LEDs Relays Inputs

Buttons: Confirm, Rename LEDs

Name	Input 1	Input 2	Input 3
▶ Over Current 1			
Over Current 2			
Over Current 3			
Neutral Over Current 1			
Neutral Over Current 2			
Neutral Over Current 3			
Negative Sequence			
Under Current			
Broken Conductor			
Trip Circuit Supervision			
Auto Reclose			
LED for phase A			
LED for phase B			
LED for phase C			
LED for Under Block			
Circuit Breaker Open LED			
Circuit Breaker Close LED			
Input 1			
Input 2			
Input 3			

Connection matrix for LED settings

Configuration setting items:

You can have two types of access from this menu:

1- To set relay configuration parameters consisting:

- Phase and earth CT primary and secondary nominal current.
- Selection of active group
- Blocking parameters for under current protection (By one of inputs 1 or 2 or by defining a lower threshold, and LED for block condition indication)
- Selection operation mode, based upon FFT or true RMS. If FFT is selected, Inrush restrain function will not be used. (For over current protection, FFT is recommended.)
- Defining baud rate and address for RS485 communication.
- Defining a name & serial No. for relay. These will be shown in the event & fault records to know to which relay these information belongs.

Note: These settings will be used in all protection and automation functions.

2- To extract events, faults, and disturbances

Update relay with all settings

Save existing settings to a file

Load a before saved setting from a file to relay.

Also connection matrix enables you to observe “inputs/outputs – functions” relation to avoid any interference in functions. It can be seen for both groups 1 or 2 by selecting from up right of the page.

A sample of this matrix is shown in the next page.

Identity check ensures you that event & fault files are intact (not manipulated).

Before any update of relay if the password of relay is changed from its default, the software asks for relay password. If you don't know the relay password, you are not able to update relay settings. If relay password is default password, software doesn't ask for password.

Also during any update of relay from “MAPro setting software” it asks for permission to set the time of relay with the time of computer. If “yes” is selected, the relay time will be synchronized with computer time and if “no” is selected, the relay time will remain unchanged.

I>, I>>, I>>>, IE>, IE>>, IE>>>, I2> protection settings:

In this condition you can set the system in offline mode, save it and use for setting the systems.

For example to set I> parameters you will have this menu. All the required parameters which are needed for this function will be set in this menu. The yellow band is for settings of group1 and the blue band is for settings of group2. The active group can be selected from related unit in “settings” menu.

If you want relay operate in DMT mode (fixed time operation), select DMT in “Function” unit, and then define DMT time in second. If you want relay operate according to one of IDMT curves (one of 5 IEC curves or 3 IEEE curves), select the related curve, and then set the TMS (time multiplier). If you active the “Output latch”, after tripping, the relay (i.e. output relays and LEDs) will not reset until pushing “clear” key for 3 seconds.

Note: Because none of output relays is fixed for tripping, so the trip relay should be selected From related menu.

MAPro10 Rev 30 (OFFLINE MODE)

Measurement Settings I> I>> I>>> IE> IE>> IE>>> I2> I< A.R Inrush TCS CLP B.C. Logic C.B. Ctrl

Code: 50/51

Active Group 1

> Off

Threshold	Function	DMT Time(s)	TMS	LED pick up	LED trip
1.00	SI	0.00	0.01	LED Off	LED Off

Reset time settings

Function	DMT Time(s)	TMS
DMT	0.00	0.10

Relays

<input type="checkbox"/>	1	<input type="checkbox"/>	3	<input type="checkbox"/>	5	<input type="checkbox"/>	7
<input type="checkbox"/>	2	<input type="checkbox"/>	4	<input type="checkbox"/>	6	<input type="checkbox"/>	8

Output latch

Active Group 2

> Off

Threshold	Function	DMT Time(s)	TMS	LED pick up	LED trip
1.00	SI	0.00	0.01	LED Off	LED Off

Reset time settings

Function	DMT Time(s)	TMS
DMT	0.00	0.10

Relays

<input type="checkbox"/>	1	<input type="checkbox"/>	3	<input type="checkbox"/>	5	<input type="checkbox"/>	7
<input type="checkbox"/>	2	<input type="checkbox"/>	4	<input type="checkbox"/>	6	<input type="checkbox"/>	8

Output latch

Connection Matrix

Import Setting from PC Export Setting to PC Upload Setting to Relay

Setting has been imported successfully at 14:37:22

Computer setting menu for I> protection

Setting for other protections, I>>, I>>>, IE>, IE>>, IE>>>, I2>, are the same.

As I>>> and IE>>> only operate in DMT mode, so units "Function", "TMS", "LED pick up", and "Reset time" units are not active in related menus.

Auto reclose setting menu:

MAPro10 Rev 30 (OFFLINE MODE)

Measurement Settings I> I>> I>>> IE> IE>> IE>>> I2> I< A.R. Inrush TCS CLP B.C. Logic C.B. Ctrf

Code: 79

Active Group 1

Active
 EXT Control
 CB Ready
 Inhibit time

ARTripBy: External
 Input 52a: 1
 CYCL: 4
 ReCIm(s): 0.01
 Input EXT: 2
 Input CBR: 3
 Input IHB: 4

AR input: 5
 D1 (s): 0.01
 D2 (s): 0.01
 D3 (s): 0.01
 D4 (s): 0.01
 CBR(s): 0.01
 IHB(s): 0

AR Active for:
 I>
 I>>
 I>>>
 le>
 le>>
 le>>>

Relays: 1, 2, 3, 4, 5, 6, 7, 8

LED: Progress Off, Success Off, Lockout Off
 Relay: Off, Off, Off

Active Group 2

Active
 EXT Control
 CB Ready
 Inhibit time

ARTripBy: Internal
 Input 52a: 1
 CYCL: 2
 ReCIm(s): 0.03
 Input EXT: 2
 Input CBR: 3
 Input IHB: 4

D1 (s): 0.01
 D2 (s): 0.01
 CBR(s): 0.01
 IHB(s): 0

AR Active for:
 I>
 I>>
 I>>>
 le>
 le>>
 le>>>

Relays: 1, 2, 3, 4, 5, 6, 7, 8

LED: Progress Off, Success Off, Lockout Off
 Relay: Off, Off, Off

Connection Matrix

Import Setting from PC Export Setting to PC Upload Setting to Relay

Setting has been imported successfully at 14:37:22

Auto reclose setting menu

The following settings are existed in this menu:

(In the following part, CB means circuit breaker)

1- Active, to activate or deactivate the auto reclose function in the related group

2- CB Ready, if selected, before reclosing, relay checks CB to be ready for close. It is checked from the selected digital input.

3- EXT control, if selected, you can deactivate auto reclose from an external source through the selected digital input, even if it is active in software. (If selected, auto reclose doesn't work

when the related digital input is “0” (low).

4- CBR T(s): If you want auto reclose check CB ready signal, relay will wait by this time for CB to be ready if it is not, at the end of any dead time. If CB is still not ready after this time, auto reclose process will be blocked, and process LED turns off and lockout LED turns on.

5- Input EXT: Here define the number of digital input you have considered for deactivating auto reclose process from an external source.

6- Input 52a: Here define the number of digital input you have considered to inform relay about CB operation to open or close.

1 in related input means CB closed and 0 in this input means CB is open.

Note: This input is mandatory for auto reclose to operate, so if relay can't sense the situation of 52a, auto reclose doesn't work

7- Cycles: You can define 1, 2, 3, or 4 cycles (shots) for auto reclose operation.

8- D1, D2, D3, D4 (s): To define individually dead times in second for every cycle.

9- Recl. T (s): To define reclaim time in second.

10- In the next 3 columns you can specify for which protections you want auto reclose to operate.

11- In relays part the relays considered to close the CB can be selected.

12- Below the relays part, you can specify 3 LEDs to show the status of auto reclose operation. Process LED shows that auto reclose operation is in process. Success LED shows that auto reclose operation has been finished successfully. Lockout LED shows that auto reclose operation has been blocked because of CB not ready or any interruption. These LEDs will be reset by pushing “clear” key for 3 seconds.

Direct digital input operation menu

MAPro10 Rev 30 (OFFLINE MODE)

Measurement Settings I> I>> I>>> IE> IE>> IE>>> I2> I< A.R Inrush TCS CLP B.C. Logic C.B. Ctrl

Active Group 1

Input 1 Input 2 Input 3

Relays

LED Off LED

Input 4 Input 5

Active Group 2

Input 1 Input 2 Input 3

Relays

LED Off LED

Input 4 Input 5

Relays

LED Off LED

Connection Matrix

Import Setting from PC Export Setting to PC Upload Setting to Relay

Setting has been imported successfully at 14:37:22

Direct digital input operation menu

From this menu, you can specify each of digital inputs, to activate each of outputs relays or LEDs in both groups.

Inrush restrain setting menu

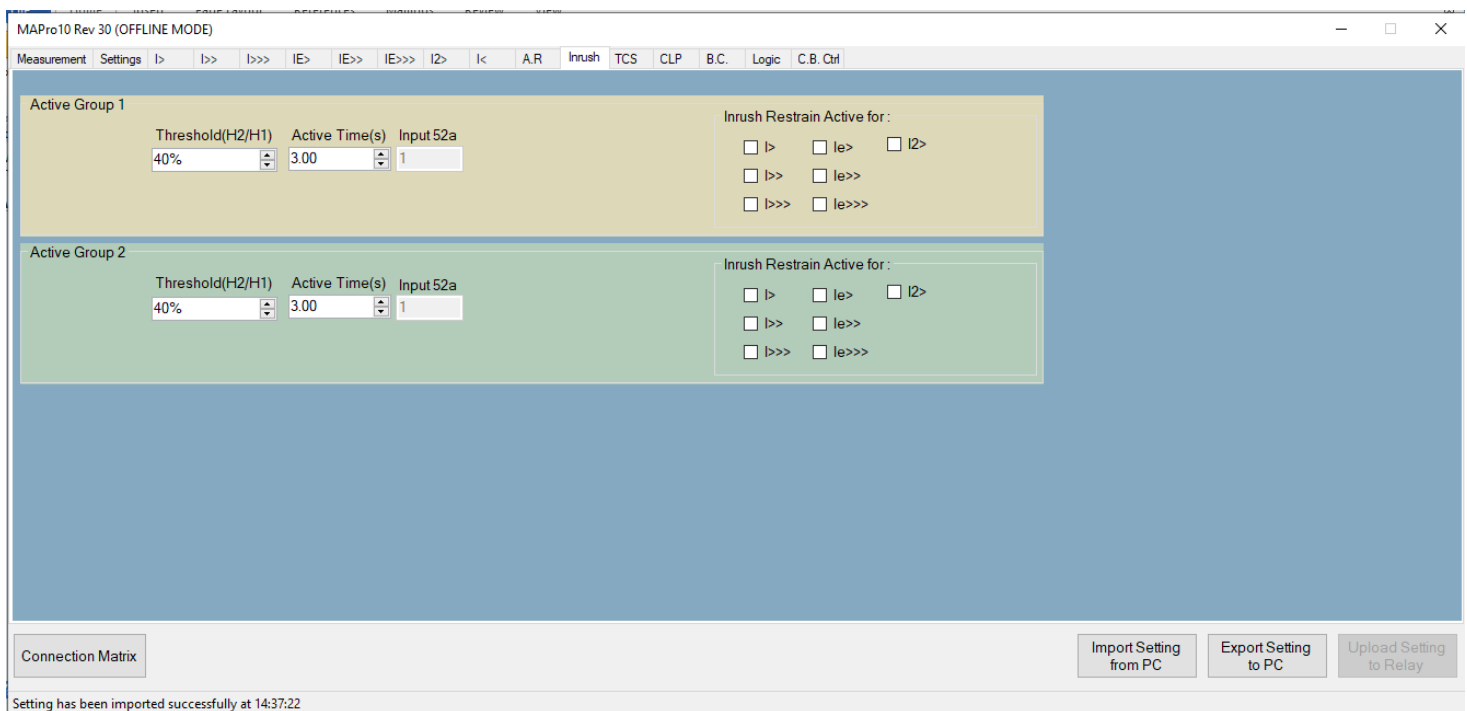

Inrush restrain setting menu

If the relay is operating in true RMS mode, the “inrush restrain” function can be activated to avoid 2nd harmonic part of input current to cause trip in specified condition.

This function can be selected to operate for any of protection functions you specify in the menu.

The number in threshold defines the ratio of “2nd harmonic RMS/1st harmonic RMS” threshold.

Under this threshold, the selected protection function operates and over this threshold, the selected protection function will not operate until the time defined in “Time (10ms)” is over.

U – 2.5: Modbus data base

Adress(Hex)	Prot. Group	Description	Values Range	Step	Unit	Format	Default
0		Protection group	1 , 2	1		F1A	1
1	50/51	l> operate or not	0 - 1	1		F24A	0
2		l> Value	000A - 09C4	1	0.01In	F1	64
3		Trip time curve l>				F3	0
4		DMT trip time l>	0000 - EA60	1	0.01S	F1	0
5		l> trip time multiplier(TMS)	000A - 05DC	1	0.001	F1	A
7		l> DMT reset time	0000 - EA60	1	0.01S	F1	0
9&10		l> Pick up&Trip LED (Binary code)	00 - 09 each	1		F3B	9
11		l> Trip relays(Binary code)	00 - 88	1		F3A	0
12		l> output latch or not	0 - 1	1		F24A	0
13	50/51	l>> operate or not	0 - 1	1		F24A	0
14		l>> Value	000A - 09C4	1	0.01In	F1	64
15		Trip time curve l>>				F3	0
16		DMT trip time l>>	0000 - EA60	1	0.01S	F1	0
17		l>> trip time multiplier(TMS)	000A - 05DC	1	0.001	F1	A
19		l>> DMT reset time	0000 - EA60	1	0.01S	F1	0
21/22		l>> Pick up/Trip LED(Binary code)	00 - 09 each	1		F3A	9
23		l>> Trip relays	00 - 88	1		F3A *	0
24		l>> output latch or not	0 - 1	1		F24A	0
25	50/51	l>>> operate or not	0 - 1	1		F24A	0
26		l>>> Value	0032 - 0FA0	1	0.01In	F1	64
Not used		l>>> operate on sample or not	0 - 1	1		F24A	0
27		DMT trip time l>>>	0000 - EA60	1	0.01S	F1	0
29		l>>>Trip LED	0-7	1		F3B	
30		l>>> Trip relays(Binary code)	00 - 88	1		F3A	0
32	50n/51n	le> operate or not	0 - 1	1		F24A	0
33		le> Value	0001 - 0320	1	0.01In	F1	64
34		Trip time curve le>				F3	0
35		DMT trip time le>	0000 - EA60	1	0.01S	F1	0
36		le> trip time multiplier(TMS)	000A - 05DC	1	0.001	F1	A
38		le> DMT reset time	0000 - EA60	1	0.01S	F1	0
40/41		le> Pick up/Trip LED(Binary code)	00 - 77	1		F3A	0/0
42		le> Trip relays	00 - 88	1		F3A	0
43		le> output latch or not	0 - 1	1		F24A	0
44	50n/51n	le>> operate or not	0 - 1	1		F24A	0
45		le>> Value	0001 - 0320	1	0.01In	F1	64
46		Trip time curve le>>				F3	0
47		DMT trip time le>>	0000 - EA60	1	0.01S	F1	0
48		le>> trip time multiplier(TMS)	000A - 05DC	1	0.001	F1	A
50		le>> DMT reset time	0000 - EA60	1	0.01S	F1	0
52/53		le>> Pick up/Trip LED	00 - 77	1		F3A	0/0
54		le>> Trip relays(Binary code)	00 - 88	1		F3A	0
55		le>> output latch or not	0 - 1	1		F24A	0

Address(Hex)	Prot. Group	Description	Values Range	Step	Unit	Format	Default
56	50n/51n	le>>> operate or not	0 - 1	1		F24A	0
57		le>>> Value	0001 - 0320	1	0.01In	F1	64
not used		le>>> operate on sample or not	0 - 1	1		F24A	0
58		DMT trip time le>>>	0000 - EA60	1	0.01S	F1	0
60		le>>> Trip LED	0-7	1		F3B	
61		le>>> Trip relays(Binary code)	00 - 88	1		F3A	0
63	Unbalance	I2> operate or not	0 - 1	1		F24A	0
64		I2> Value	000A - 09C4	1	0.01In	F1	64
65		IDMT trip time curve I2>				F3	0
66		DMT trip time I2>	0000 - EA60	1	0.01S	F1	0
67		I2> trip time multiplier(TMS)	000A - 05DC	1	0.001	F1	A
68		I2> DMT reset time	0000 - EA60	1	0.01S	F1	0
69		I2> Trip LED	0 - 7	1		F3B	0
70		I2> Trip relays(Binary code)	00 - 88	1		F3A	0
72	TCS	TCS(trip circuit supervision) yes/no	0 - 1	1		F24A	0
73		Input for 52a contact in TCS	0 - 5	1		F3B	0
74		Max permitted delay of C.B. in TCS	2 - 64h, 2 - 100	1	0.01S	F1A	2
75		TCS alarm LED	0 - 7	1		F3B	0
76		TCS output relay	00 - 88	1		F3A	0/0
	A.R. 79						
1035		Auto reclose active	0 - 1	1		F24A	0
1036		CB ready check enable	0 - 1	1		F24A	
1037		External control enable	0 - 1	1		F24A	
1038		No. of input for external control	0 - 5	1		F3B	
1039		No. of input for 52a condition	0 - 5	1		F3B	
1040		No. of input for CB ready signal	0 - 5	1		F3B	
1041		Close relay No.(Binary code)	00 - 88	1		F3A	0
1042		Auto reclose cycles	1 to 4	1		F3B	
1043		AR active for I> protection	0 - 1	1		F24A	
1044		AR active for I>> protection	0 - 1	1		F24A	
1045		AR active for I>>> protection	0 - 1	1		F24A	
1046		AR active for le> protection	0 - 1	1		F24A	
1047		AR active for le>> protection	0 - 1	1		F24A	
1048		AR active for le>>> protection	0 - 1	1		F24A	
1049		AR active for Ise> protection	0 - 1	1		F24A	
1050		AR active for Ise>> protection	0 - 1	1		F24A	
1051		AR active for Ise>>> protection	0 - 1	1		F24A	
1057		AR in progress LED No.	0 - 7	1		F3B	0
1058		AR locked out LED No.	0 - 7	1		F3B	0
1059		AR successful LED No.	0 - 7	1		F3B	0
1060		Permitted time for CB ready(CBRT)	0001 - EA60	1	0.01S	F1	
1061							
1062							
1063		D1 (first cycle dead time)	0001 - EA60	1	0.01S	F1	1
1064		D2 (first cycle dead time)	0001 - EA60	1	0.01S	F1	1
1065		D3 (first cycle dead time)	0001 - EA60	1	0.01S	F1	1
1066		D4 (first cycle dead time)	0001 - EA60	1	0.01S	F1	1
1067		Reclame time	0001 - EA60	1	0.01S	F1	1

	I/O logic					
	Input1 LED	0 - 7	1		F3B	0
	Input1 relay(Binary code)	00 - 88	1		F3A	0
	Input2 LED	0 - 7	1		F3B	0
	Input2 relay	00 - 88	1		F3A	0
	Input3 LED	0 - 7	1		F3B	0
	Input3 relay	00 - 88	1		F3A	0
	Input4 LED	0 - 7	1		F3B	0
	Input4 relay	00 - 88	1		F3A	0
	Input5 LED	0 - 7	1		F3B	0
	Input5 relay	00 - 88	1		F3A	0
	Last fault					
94	type relay					
95	Type of MAPro relay				F1	
96	fma ?					
97	fma ?					
98	Firmware version				F1	
99	Firmware revision				F1	
100 !	input state				?	
101 !	relay state				?	
102 !	led state				?	
103	LF year				F1	
104	LF M				F1	
105	LF D				F1	
106	LF H				F1	
107	LF Min				F1	
108	LF Sec				F1	
109	LF mSec.				F1	
110 ?	LF index					
111 ?	LF trip level					
112	LF trip cur	OK				
113	LF IA					
114	LF IB					
115	LF IC					
116	LF IE					
117	LF I1					
118	LF I2					

Address(Hex)	Prot. Group	Description	Values Range	Step	Unit	Format	Default
	Inrush BLK						
		h2/h1 threshold value	01 - 64h		0.01		
		Inrush restrain time	0 - BB8h		0.01S		
		Inrush res. active for l> protection	0 - 1	1		F24A	
		Inrush res. active for l>> protection	0 - 1	1		F24A	
		Inrush res. active for l>>> protection	0 - 1	1		F24A	
		Inrush res. active for le> protection	0 - 1	1		F24A	
		Inrush res. active for le>> protection	0 - 1	1		F24A	
		Inrush R. active for le>>> protection	0 - 1	1		F24A	
		Inrush res. active for lse> protection	0 - 1	1		F24A	
		Inrush R. active for lse>> protection	0 - 1	1		F24A	
		Inrush R active for lse>>> protection	0 - 1	1		F24A	
		Inrush res. active for l2> protection	0 - 1	1		F24A	
		No. of input for 52a condition	0 - 5	1		F3B	
	CLP						
832		CLP active?					
833		CLP active for l> protection	0 - 1	1		F24A	
834		CLP active for l>> protection	0 - 1	1		F24A	
835		CLP active for l>>> protection	0 - 1	1		F24A	
836		CLP active for le> protection	0 - 1	1		F24A	
837		CLP active for le>> protection	0 - 1	1		F24A	
838		CLP active for le>>> protection	0 - 1	1		F24A	
839		CLP active for lse> protection	0 - 1	1		F24A	
840		CLP active for lse>> protection	0 - 1	1		F24A	
841		CLP active for lse>>> protection	0 - 1	1		F24A	
842		CLP active for l2> protection	0 - 1	1		F24A	
843		CLP percent of thresholds increase	0Ah - 57E40h		0.01S		
844		CLP time of threshold increase					
845		No. of input for 52a condition	0 - 5	1		F3B	
	Under Curr						
846		Under current protection(l<) active?					
847		l< Value	000A - 09C4	1	0.01In	F1	64
848		DMT trip time l<	0000 - EA60	1	0.01S	F1	0
849		l< Trip LED	0 - 7	1		F3B	0
850		l< Trip relays(Binary code)	00 - 88	1		F3A	0
851		Output contact latch					
	BC						
852*		B.C. active?					
853*		l2/l1 threshold value					
854*		Definite time for B.C. trip					
855*		B.C. Trip LED	0 - 7	1		F3B	0
856*		B.C. Trip relays(Binary code)	00 - 88	1		F3A	0

Adress(Hex)	Prot. Group	Description	Values Range	Step	Unit	Format	Default
	Events						
119		E1 E code					
120		E1 parameter High nibble					
121		E1 parameter low nibble					
122		E1 Y					
123		E1 M					
124		E1 D					
125		E1 H					
126		E1 Min					
127		E1 Sec					
128		E1 ms					
129 - 138		Event2					
139 - 148		Event3					
149 - 158		Event4					
159 - 168		Event5					
169 - 178		Event6					
179 - 188		Event7					
189 - 198		Event8					
199 - 208		Event9					
209 - 218		Event10					
219 - 228		Event11					
229 - 238		Event12					
239 - 248		Event13					
249 - 258		Event14					
259 - 268		Event15					
269 - 278		Event16					
279 - 288		Event17					
289 - 298		Event18					
299 - 308		Event19					
309 - 318		Event20					
319 - 328		Event21					
329 - 338		Event22					
339 - 348		Event23					
349 - 358		Event24					
359 - 368		Event25					
369 - 378		Event26					
379 - 388		Event27					
389 - 398		Event28					
399 - 408		Event29					
409 - 418		Event30					
419 - 428		Event31					
429 - 438		Event32					
439 - 448		Event33					
449 - 458		Event34					
459 - 468		Event35					
469 - 478		Event36					
479 - 488		Event37					
489 - 498		Event38					

Address(Hex)	Prot. Group	Description	Values Range	Step	Unit	Format	Default
499 - 508		Event39					
509 - 518		Event40					
519 - 528		Event41					
529 - 538		Event42					
539 - 548		Event43					
549 - 558		Event44					
559 - 568		Event45					
569 - 578		Event46					
579 - 588		Event47					
589 - 598		Event48					
599 - 608		Event49					
609 - 618		Event50					
619 - 628		Event51					
629 - 638		Event52					
639 - 648		Event53					
649 - 658		Event54					
659 - 668		Event55					
669 - 678		Event56					
679 - 688		Event57					
689 - 698		Event58					
699 - 708		Event59					
709 - 718		Event60					
719 - 728		Event61					
729 - 738		Event62					
739 - 748		Event63					
749 - 758		Event64					
759 - 768		Event65					
769 - 778		Event66					
779 - 788		Event67					
789 - 798		Event68					
799 - 808		Event69					
809 - 818		Event70					
819 - 828		Event71					
829 - 838		Event72					
839 - 848		Event73					
849 - 858		Event74					
859 - 868		Event75					

Address(Hex)	Prot. Group	Description	Values Range	Step	Unit	Format	Default
	Faults						
		F1 Y					
868 +1		F1M					
869		F1 D					
870		F1 H					
871		F1 Min					
872		F1 Sec					
873		F1 ms					
874		F1 phase index					
875		F1 trip level					
876		F1 I trip					
877		F1 IA					
878		F1 IB					
879		F1 IC					
880		F1 IE					
881		F1 I1					
882		F1 I2					
883 +1		F2					
885 - 900		F3					
901 - 916		F4					
917 - 932		F5					
933 - 948		F6					
949 - 964		F7					
965 - 980		F8					
981 - 996		F9					
997 - 1012		F10					
1013 - 1028							
	TIME:						
1029		Mounth					
1030		Day					
1031		Hour					
1032		Minute					
1033		Second					
1034							

U – 2.6: Modbus data format

Code	Description
F1	Unsigned integer: Numerical data 0 to 65535 (16 bits)
F1B	Signed integer 0 to +32767/-32768
F1A	Unsigned integer: Numerical data 0 to 255 (8 bits)
F3	08: DMT 00: IEC STI 01: IEC SI 02: IEC VI 03: IEC EI 04: IEC LTI 05: IMI (IEEE moderately inverse) 06: MI (IEEE very inverse) 07: IEI (IEEE extremely inverse) 20: Reset IMI (IEEE moderately inverse for reset) 21: Reset MI (IEEE very inverse for reset) 22: Reset IEI (IEEE extremely inverse for reset)
F3A	Unsigned Hex number 00H to FFH
F3B	Unsigned Hex number 00H to 0FH
F5	ASCII code
F24A	Unsigned integer: 0=no, 1=yes
F24B	Unsigned integer: 0=9600,1=19200,2=38400
F24C	Unsigned integer: 0=1A , 1=5A
F24D	Unsigned integer: 0=ABC , 1=ACB
F24E	Unsigned integer: 0=ABCN , 1=RSTG , 2=L1L2L3E
F3F	00: l> 01: l>> 02: l>>> 03: le> 04: le>> 05: le>>> 06: l2>
F3G	00: Phase A 01: Phase B 02: Phase C 03: Earth

U – 2.7:

Type test certificate

Tavanir authorization

Accredited lab in Electrical, Gas, Oil, Telecommunications, Household IT, Electro-Medical, Renewable Energy, Luminaires, ... Industries	E.P.I.L. Energy & Power Industries Laboratories Co.(P.S.C.)	ISO 17025 Accredited Lab
---	---	--------------------------

TI-4009(1)-160255 Page 1 of 1 LQF-510-02

TYPE TEST REPORT

Project No.: TI-4009(1)-160255

We hereby, verify that the following mentioned electrical product submitted to the tests in our laboratory, within the period 1 Dec 2015– 30 Apr 2016, and is in compliance with the related clauses and sub-clauses of standards IEC 60255.

Equipment under Test:

Current Protection Relay

Model/Type	: MAPro 10
Serial Number	: 155680
Rating	: 60-160 VDC



Manufactured By: Fars Mehvar Azma Co.

Issue Date: 8-Jun-2016

The full description of applicable type tests and pictures of relay are available in the test reports 3275, 3285 and TI-4009-T11.

LV/EMC Technical
Manager
S. M. Mirfallah

Vice President
of CEO
S.M. Mirsadri

Engineering Deputy of
Test and Inspection
Prof. B. Wahidi

E.P.I.L.
Technical Department
ISO IEC 17025
Accredited Lab

*This report should not be reproduced in extracts without written approval by EPIL.
Test results pertain to the tested sample only.
Not Valid Without Lab Stamp.*

Office: Unit 6, No. 5, Corner of Razvan St., South Shiraz Ave. Shahid Hemmat Expressway Tehran - Iran Zip Code:1438854817

تاریخ: ۱۳۹۵/۷/۱۳	 شرکت مدیریت تولید، انتقال و توزیع نیروی برق ایران توانیر	
شماره: ۱۱/۳۵۳۳		
پوست: دارد		

بسمه تعالی

« سال ۱۴ سال انصاف مقاومتی، اقدام و عمل »

(استمطربیرا)

کلیه شرکتهای برق منطقه‌ای و سازمان آب و برق خوزستان

موضوع: رله های حفاظتی تولید داخل

با سلام،

نظر به بررسی های بعمل آمده توسط دفتر فنی و نظارت شبکه انتقال این شرکت در رابطه با رله های حفاظتی ساخت شرکت محور آزماي فارس، با توجه به دریافت گواهی تست های نوعی بر روی رله جریان زیاد جهت دار تومریکال مدل **MAPro-10** و رله ولتاژی مدل **MAPro-30** و همچنین عملکرد موفقیت آمیز آنها در بهره برداری پایلوت، استفاده از رله های مذکور در شبکه توزیع و فوق توزیع کشور بلامانع میباشد.

بنابراین در راستای اقتصاد مقاومتی و حمایت از تولیدات داخلی استفاده از رله های فوق الذکر با رعایت ضوابط و قوانین جاری کشور در اولویت خرید قرار گیرد.



مدیرعامل

رونوشت:

- جناب آقای دکتر صالحی ریاست محترم مرکز طرحهای کلان ملی فناوری - معاونت علمی ریاست جمهوری جهت استحضار و اقدام لازم
- شرکت مدیریت شبکه برق ایران
- شرکت مهندسی مشاور ستار
- شرکت مهندسی مشاور قفس نیرو
- شرکت مهندسی مشاور سونکو
- معاونت هماهنگی انتقال
- معاونت هماهنگی توزیع

تهران - میدان ولیعهد - خیابان نهید ماسپور - ساختمان مرکزی شرکت توانیر - صندوق پستی: ۶۲۲۷ - ۱۴۱۵۵ - تلفن: ۴۲۳۲۱ - فاکس: ۸۷۲۹۵۲۲ - ۹۵۶۳۱-۳۱۶۶۶

پست الکترونیکی: Info@Tavanir.org.ir | پایگاه اینترنتی: www.Tavanir.org.ir

U – 2.8: IEC 60870-5-103 compatibility

8 Interoperability

8.1 Physical layer

8.1.1 Electrical interface

- EIA RS-485
 Number of loads for one protection equipment

NOTE – EIA RS-485 standard defines unit loads so that 32 of them can be operated on one line. For detailed information refer to clause 3 of EIA RS-485 standard.

8.1.2 Optical interface

- Glass fibre
 Plastic fibre
 F-SMA type connector
 BFOC/2,5 type connector

8.1.3 Transmission speed

- 9 600 bit/s
 19 200 bit/s

8.2 Link layer

There are no choices for the link layer.

8.3 Application layer

8.3.1 Transmission mode for application data

Mode 1 (least significant octet first), as defined in 4.10 of IEC 60870-5-4, is used exclusively in this companion standard.

8.3.2 COMMON ADDRESS of ASDU

- One COMMON ADDRESS OF ASDU (identical with station address)
 More than one COMMON ADDRESS OF ASDU

8.3.3 Selection of standard information numbers in monitor direction

8.3.3.1 System functions in monitor direction

INF	Semantics
<input checked="" type="checkbox"/>	<0> End of general interrogation
<input checked="" type="checkbox"/>	<0> Time synchronization
<input type="checkbox"/>	<2> Reset FCB
<input checked="" type="checkbox"/>	<3> Reset CU
<input type="checkbox"/>	<4> Start/restart
<input type="checkbox"/>	<5> Power on

8.3.3.2 Status indications in monitor direction

INF	Semantics
<input checked="" type="checkbox"/>	<16> Auto-recloser active
<input type="checkbox"/>	<17> Teleprotection active
<input checked="" type="checkbox"/>	<18> Protection active
<input checked="" type="checkbox"/>	<19> LED reset
<input checked="" type="checkbox"/>	<20> Monitor direction blocked
<input type="checkbox"/>	<21> Test mode
<input checked="" type="checkbox"/>	<22> Local parameter setting
<input type="checkbox"/>	<23> Characteristic 1
<input type="checkbox"/>	<24> Characteristic 2
<input type="checkbox"/>	<25> Characteristic 3
<input type="checkbox"/>	<26> Characteristic 4
<input checked="" type="checkbox"/>	<27> Auxiliary input 1
<input checked="" type="checkbox"/>	<28> Auxiliary input 2
<input checked="" type="checkbox"/>	<29> Auxiliary input 3
<input checked="" type="checkbox"/>	<30> Auxiliary input 4

8.3.3.3 Supervision indications in monitor direction

INF	Semantics
<input checked="" type="checkbox"/>	<32> Measurand supervision I
<input type="checkbox"/>	<33> Measurand supervision V
<input checked="" type="checkbox"/>	<35> Phase sequence supervision
<input checked="" type="checkbox"/>	<36> Trip circuit supervision
<input type="checkbox"/>	<37> I>> back-up operation
<input type="checkbox"/>	<38> VT fuse failure
<input type="checkbox"/>	<39> Teleprotection disturbed
<input type="checkbox"/>	<46> Group warning
<input type="checkbox"/>	<47> Group alarm

8.3.3.4 Earth fault indications in monitor direction

INF	Semantics
<input checked="" type="checkbox"/>	<48> Earth fault L ₁
<input checked="" type="checkbox"/>	<49> Earth fault L ₂
<input checked="" type="checkbox"/>	<50> Earth fault L ₃
<input type="checkbox"/>	<51> Earth fault forward, i.e. line
<input type="checkbox"/>	<52> Earth fault reverse, i.e. busbar

8.3.3.5 Fault indications in monitor direction

INF	Semantics
<input type="checkbox"/>	<64> Start /pick-up L ₁
<input type="checkbox"/>	<65> Start /pick-up L ₂
<input type="checkbox"/>	<66> Start /pick-up L ₃
<input type="checkbox"/>	<67> Start /pick-up N
<input checked="" type="checkbox"/>	<68> General trip
<input type="checkbox"/>	<69> Trip L ₁
<input type="checkbox"/>	<70> Trip L ₂
<input type="checkbox"/>	<71> Trip L ₃
<input type="checkbox"/>	<72> Trip I>> (back-up operation)
<input type="checkbox"/>	<73> Fault location X in ohms
<input type="checkbox"/>	<74> Fault forward/line
<input type="checkbox"/>	<75> Fault reverse/busbar
<input type="checkbox"/>	<76> Teleprotection signal transmitted
<input type="checkbox"/>	<77> Teleprotection signal received
<input type="checkbox"/>	<78> Zone 1
<input type="checkbox"/>	<79> Zone 2
<input type="checkbox"/>	<80> Zone 3
<input type="checkbox"/>	<81> Zone 4
<input type="checkbox"/>	<82> Zone 5
<input type="checkbox"/>	<83> Zone 6
<input checked="" type="checkbox"/>	<84> General start/pick-up
<input type="checkbox"/>	<85> Breaker failure
<input type="checkbox"/>	<86> Trip measuring system L ₁
<input type="checkbox"/>	<87> Trip measuring system L ₂
<input type="checkbox"/>	<88> Trip measuring system L ₃
<input type="checkbox"/>	<89> Trip measuring system E
<input type="checkbox"/>	<90> Trip I>
<input type="checkbox"/>	<91> Trip I>>
<input type="checkbox"/>	<92> Trip IN>
<input type="checkbox"/>	<93> Trip IN>>

8.3.3.6 Auto-reclosure indications in monitor direction**INF Semantics**

- <128> CB 'on' by AR
- <129> CB 'on' by long-time AR
- <130> AR blocked

8.3.3.7 Measurands in monitor direction**INF Semantics**

- <144> Measurand I
- <145> Measurands I, V
- <146> Measurands I, V, P, Q
- <147> Measurands I_N, V_{EN}
- <148> Measurands $I_{L1,2,3}, V_{L1,2,3}, P, Q, f$

8.3.3.8 Generic functions in monitor direction**INF Semantics**

- <240> Read headings of all defined groups
- <241> Read values or attributes of all entries of one group
- <243> Read directory of a single entry
- <244> Read value or attribute of a single entry
- <245> End of general interrogation of generic data
- <249> Write entry with confirmation
- <250> Write entry with execution
- <251> Write entry aborted

8.3.4 Selection of standard information numbers in control direction**8.3.4.1 System functions in control direction****INF Semantics**

- <0> Initiation of general interrogation
- <0> Time synchronization

8.3.4.2 General commands in control direction

INF Semantics

- <16> Auto-recloser on/off
- <17> Teleprotection on/off
- <18> Protection on/off
- <19> LED reset
- <23> Activate characteristic 1
- <24> Activate characteristic 2
- <25> Activate characteristic 3
- <26> Activate characteristic 4

8.3.4.3 Generic functions in control direction

INF Semantics

- <240> Read headings of all defined groups
- <241> Read values or attributes of all entries of one group
- <243> Read directory of a single entry
- <244> Read value or attribute of a single entry
- <245> General interrogation of generic data
- <248> Write entry
- <249> Write entry with confirmation
- <250> Write entry with execution
- <251> Write entry abort

8.3.5 Basic application functions

- Test mode
- Blocking of monitor direction
- Disturbance data
- Generic services
- Private data

8.3.6 Miscellaneous

Measurands are transmitted with ASDU 3 as well as with ASDU 9. As defined in 7.2.6.8, the maximum MVAL can either be 1,2 or 2,4 times the rated value. No different rating shall be used in ASDU 3 and ASDU 9, i.e. for each measurand there is only one choice.

Measurand	Max. MVAL = rated value times	
	1,2	or 2,4
Current L ₁	<input type="checkbox"/>	<input checked="" type="checkbox"/>
Current L ₂	<input type="checkbox"/>	<input checked="" type="checkbox"/>
Current L ₃	<input type="checkbox"/>	<input checked="" type="checkbox"/>
Voltage L _{1-E}	<input type="checkbox"/>	<input type="checkbox"/>
Voltage L _{2-E}	<input type="checkbox"/>	<input type="checkbox"/>
Voltage L _{3-E}	<input type="checkbox"/>	<input type="checkbox"/>
Active power P	<input type="checkbox"/>	<input type="checkbox"/>
Reactive power Q	<input type="checkbox"/>	<input type="checkbox"/>
Frequency f	<input type="checkbox"/>	<input type="checkbox"/>
Voltage L ₁ - L ₂	<input type="checkbox"/>	<input type="checkbox"/>